

DRR244

Controller



User manual

Table of contents

1	Safety guidelines.....	6
1.1	Organization of safety notices.....	6
1.2	Safety Precautions.....	6
1.3	Precautions for safe use.....	7
1.4	Environmental policy / WEEE.....	7
2	Model Identification.....	8
3	Technical Data.....	8
3.1	General Features.....	8
3.2	Hardware Features.....	8
3.3	Software Features.....	8
3.4	Programming mode.....	9
4	Dimensions and Installation.....	9
5	Electrical wirings.....	9
5.1	Wiring diagram.....	10
5.1.a	Power Supply.....	10
5.1.b	Analogue Input AI1.....	10
5.1.c	CT input.....	11
5.1.d	Digital inputs.....	11
5.1.e	Serial input.....	11
5.1.f	Digital output.....	11
5.1.g	Analogue output AO1.....	11
5.1.h	Relays output Q1 - Q2.....	11
5.1.i	Relay output Q3.....	12
6	Display and Key Functions.....	12
6.1	Meaning of Status Lights (Led).....	12
6.2	Keys.....	13
7	Controller Functions.....	13
7.1	Modification of main and alarm setpoint value.....	13
7.2	Automatic Tune.....	13
7.3	Manual Tune.....	13
7.4	Tuning once.....	14
7.5	Synchronized tuning.....	14
7.6	Digital input functions.....	14
7.7	Automatic / Manual regulation for % output control.....	15
7.8	Heater Break Alarm on CT (Current Transformer).....	16
7.9	Funzionamento in doppia azione (caldo-freddo).....	16
7.10	LATCH ON Function.....	17
7.11	Soft-Start Function.....	18
7.12	Pre-Programmed cycle.....	18
7.13	Retransmission function on analogue output.....	19
7.14	Timer functions.....	19
8	Serial communication.....	20
9	Reading and configuration through NFC.....	24
10	Access configuration.....	25
10.1	Loading default values.....	25
10.2	Parameters list functioning.....	26
11	Table of Configuration Parameters.....	26
12	Alarm Intervention Modes.....	51
12.a	Absolute or threshold alarm active over (par. 123 RL IF = Ab.uPA).....	51
12.b	Absolute or threshold alarm active below (par. 123 RL IF = Ab.uPA).....	51
12.c	Absolute or threshold alarm referred to command setpoint active over (par. 123 RL IF = Ab.c.uPA).....	51
12.d	Absolute or threshold alarm referred to command setpoint active below (par. 123 RL IF = Ab.c.LA).....	51
12.e	Band alarm (par. 123 RL IF = bAnd).....	52
12.f	Asymmetric band alarm (par. 123 RL IF = A.bAnd).....	52

12.g Upper deviation alarm (par. 123 RL IF = $uP.dEu$).....	52
12.h Lower deviation alarm (par. 123 RL IF = $Lo.dEu$)	53
12.1 Alarms label.....	53
13 Fault reporting table	54

Blank Page

Introduction

The process controller DRR244 is specifically conceived for application on control panels with DIN rail mounting. It stands out for the bright display which ensures optimal visibility and increased level of information for the operator beside a scrolling help function.

DRR244 relies on Pixsys flagship programming mode by NFC/RFID technology with dedicated App MyPixsys for Android devices (same already used for Pixsys Blue Line controllers, signal converters and STR indicators) not requiring wirings and power supply, allowing quick set-up/updates on site.

The outputs can be selected as command/multiple alarm modes/analogue retransmission. Serial communication RS485 is available with Modbus RTU/Slave protocol. Useful power supply with extended range 24 to 230VAC / VDC with galvanic insulation.

1 Safety guidelines

Read carefully the safety guidelines and programming instructions contained in this manual before connecting/using the device.

Disconnect power supply before proceeding to hardware settings or electrical wirings to avoid risk of electric shock, fire, malfunction.

Do not install/operate the device in environments with flammable/explosive gases.

This device has been designed and conceived for industrial environments and applications that rely on proper safety conditions in accordance with national and international regulations on labour and personal safety. Any application that might lead to serious physical damage/ life risk or involve medical life support devices should be avoided.

Device is not conceived for applications related to nuclear power plants, weapon systems, flight control, mass transportation systems.

Only qualified personnel should be allowed to use device and/or service it and only in accordance to technical data listed in this manual.

Do not dismantle/modify/repair any internal component.

Device must be installed and can operate only within the allowed environmental conditions. Overheating may lead to risk of fire and can shorten the lifecycle of electronic components.

1.1 Organization of safety notices

Safety notices in this manual are organized as follows:

Safety notice	Description
Danger!	Disregarding these safety guidelines and notices can be life-threatening.
Warning!	Disregarding these safety guidelines and notices can result in severe injury or substantial damage to property.
Information!	This information is important for preventing errors.

1.2 Safety Precautions

This product is UL listed as open type process control equipment.	Danger!
If the output relays are used past their life expectancy, contact fusing or burning may occasionally occur.	Danger!
Always consider the application conditions and use the output relays within their rated load and electrical life expectancy. The life expectancy of output relays varies considerably with the output load and switching conditions.	
Loose screws may occasionally result in fire.	Warning!
For screw terminals tighten screws to tightening torque of 0,51 Nm.	Warning!
A malfunction in the Digital Controller may occasionally make control operations impossible or prevent alarm outputs, resulting in property damage. To maintain safety in the event of malfunction of the Digital Controller, take appropriate safety measures, such as installing a monitoring device on a separate line.	

1.3 Precautions for safe use

Be sure to observe the following precautions to prevent operation failure, malfunction, or adverse affects on the performance and functions of the product. Not doing so may occasionally result in unexpected events. Do not handle the Digital Controller in ways that exceed the ratings.

- The product is designed for indoor use only. Do not use or store the product outdoors or in any of the following places.
 - Places directly subject to heat radiated from heating equipment.
 - Places subject to splashing liquid or oil atmosphere.
 - Places subject to direct sunlight.
 - Places subject to dust or corrosive gas (in particular, sulfide gas and ammonia gas).
 - Places subject to intense temperature change.
 - Places subject to icing and condensation.
 - Places subject to vibration and large shocks.
- Installing two or more controllers in close proximity might lead to increased internal temperature and this might shorten the life cycle of electronic components. It is strongly recommended to install cooling fans or other air-conditioning devices inside the control cabinet.
- Always check the terminal names and polarity and be sure to wire properly. Do not wire the terminals that are not used.
- To avoid inductive noise, keep the controller wiring away from power cables that carry high voltages or large currents. Also, do not wire power lines together with or parallel to Digital Controller wiring. Using shielded cables and using separate conduits or ducts is recommended. Attach a surge suppressor or noise filter to peripheral devices that generate noise (in particular motors, transformers, solenoids, magnetic coils or other equipment that have an inductance component). When a noise filter is used at the power supply, first check the voltage or current, and attach the noise filter as close as possible to the Digital Controller. Allow as much space as possible between the Digital Controller and devices that generate powerful high frequencies (high-frequency welders, high-frequency sewing machines, etc.) or surge.
- A switch or circuit breaker must be provided close to device. The switch or circuit breaker must be within easy reach of the operator, and must be marked as a disconnecting means for the controller.
- The device must be protected by a fuse 1A (cl. 9.6.2).
- Wipe off any dirt from the Digital Controller with a soft dry cloth. Never use thinners, benzine, alcohol, or any cleaners that contain these or other organic solvents. Deformation or discoloration may occur.
- The number of non-volatile memory write operations is limited. Therefore, use EEPROM write mode when frequently overwriting data, e.g.: through communications.

1.4 Environmental policy / WEEE

Do not dispose electric tools together with household waste material.

According to European Directive 2002/96EC on waste electrical and electronic equipment and its implementation in accordance with national law, electric tools that have reached the end of their life must be collected separately and returned to an environmentally compatible recycling facility.

2 Model Identification

The DRR244 controller provides the following model:

Power supply 24...230 VAC/VDC $\pm 15\%$ 50/60 Hz – 9 Watt/VA

DRR244-13ABC-T	1 analogue input + 2 relays 5 A + 1 relay 2 A + 2 SSR + 2 D.I. + 1 analogue output V/mA + RS485 + CT
----------------	--

3 Technical Data

3.1 General Features

Displays	4 digits 0,52", 5 digits 0,30"
Operating temperature	Temperature: 0-45° C -Humidity 35..95 uR% Max. altitude: 2000m
Sealing	IP20 box
Material	Box: Polycarbonate self-extinguishing; Front panel: Polyamide self-extinguishing
Weight	Approx. 210 g

3.2 Hardware Features

Analogue inputs	AI1 Configurable via software. Input: Thermocouple type K, S, R, J,T,E,N,B. Automatic compensation of cold junction from -25..85° C. Thermoresistances: PT100, PT500, PT1000, Ni100, PTC 1K, NTC 10K (β 3435K) Input V/mA: 0-1 V, 0-5 V, 0-10 V, 0-20 o 4-20 mA, 0-60 mV. Pot. Input: 1...150 K Ω . CT: 50 mA.	Tolerance (25° C) $\pm 0.2\% \pm 1$ digit (on F.s.) for thermocouple, thermoresistance and V/mA. Cold junction accuracy 0.1° C/°C. Impedence: 0-10 V: Ri>110 K Ω 0-20 mA: Ri<5 Ω 0-40 mV: Ri>1 M Ω
Relay outputs	Configurable as command and alarm output.	Contacts: Q1, Q2: 5 A - 250 VAC for resistive load. Q3: 2 A - 250 VAC for resistive load.
SSR outputs	Configurable as command and alarm output.	12/24 V, 25 mA.
Analogue output	Configurable as command and alarm output or as retrasmision of process / setpoints.	Configurable: 0-10 V with 40000 points +/-0.2% (on F.s.) 4-20 mA con 40000 points +/-0.2% (on F.s.)
Power-supply	Extended power-supply 24..230 VAC/ VDC $\pm 15\%$ 50/60 Hz	Consumption: 9 Watt/VA

3.3 Software Features

Regulation algorithms	ON-OFF with hysteresis. P, PI, PID, PD with proportional time
Proportional band	0..9999°C o °F
Integral time	0,0..999,9 sec (0 excludes)
Derivative time	0,0..999,9 sec (0 excludes)
Controller functions	Manual or automatic Tuning, selectable alarm, protection of command and alarm setpoints.

3.4 Programming mode

by keyboard	..see paragraph 9
software LabSoftview	..on "Download section" of official pixsys site: www.pixsys.net
App MyPixsys	..through download the App on Google Play Store®, see paragraph 8 When activated by a reader/interrogator supporting NFC-V protocol, controller DRR244 is to be considered a VICC (Vicinity Inductively Coupled Card) according to ISO/IEC 15693 and it operates at a frequency of 13.56 MHz. The device does not intentionally emit radio waves.

4 Dimensions and Installation

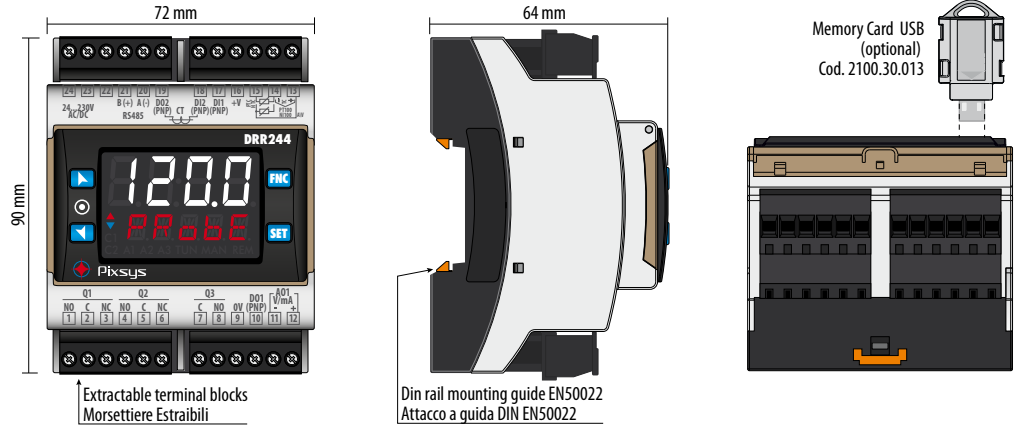

5 Electrical wirings

This controller has been designed and manufactured in conformity to Low Voltage Directive 2006/95/EC, 2014/35/EU (LVD) and EMC Directive 2004/108/EC, 2014/30/EU (EMC). For installation in industrial environments please observe following safety guidelines:

- Separate control line from power wires.
- Avoid proximity of remote control switches, electromagnetic contactors, powerful engines.
- Avoid proximity of power groups, especially those with phase control.
- It is strongly recommended to install adequate mains filter on power supply of the machine where the controller is installed, particularly if supplied 230Vac.

The controller is designed and conceived to be incorporated into other machines, therefore CE marking on the controller does not exempt the manufacturer of machines from safety and conformity requirements applying to the machine itself.

- Wiring of pins: use crimped tube terminals or flexible/rigid copper wire with diameter 0.2 to 2.5 mm² (min. AWG28, max. AWG12, operating temperature: min. 70°C). Cable stripping length 7 to 8 mm.

5.1 Wiring diagram

DRR244-13ABC-T

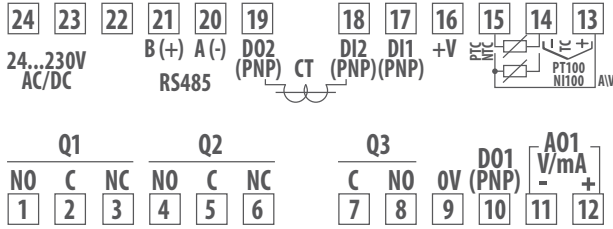

5.1.a Power Supply

<p>SUPPLY 24...230 VAC/DC</p>	<p>Switching power supply 24..230 VAC/VDC $\pm 15\%$ 50/60 Hz - 9 Watt/VA. Galvanic insulation (2500V).</p>
--	--

5.1.b Analogue Input AI1

<p>AI1</p>	<p>For thermocouples K, S, R, J, T, E, N, B.</p> <ul style="list-style-type: none"> Comply with polarity For possible extensions, use compensated cable and terminals suitable for the thermocouples used (compensated). When shielded cable is used, it should be grounded at one side only.
<p>AI1</p>	<p>For thermoresistances PT100, Ni100.</p> <ul style="list-style-type: none"> For the three-wire connection use wires with the same section. For the two-wire connection short-circuit terminals 13 and 15 When shielded cable is used, it should be grounded at one side only.
<p>AI1</p>	<p>For thermoresistances NTC, PTC, PT500, PT1000 and linear potentiometers.</p> <p>When shielded cable is used, it should be grounded at one side only to avoid ground loop currents.</p>
<p>AI1</p>	<p>For linear signals in Volt and mA</p> <ul style="list-style-type: none"> Comply with polarity When shielded cable is used, it should be grounded at one side only to avoid ground loop currents. It's possible to select +V at 12Vdc or 24Vdc, by configuring parameter 282 u.o.u.t (GROUP R - d iSP - Display and interface).

5.1.c CT input

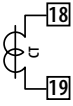

To enable CT input, modify parameter 287 $c\pm F$.

- Input for 50 mA amperometric transformer.
- Sampling time 100 ms.
- Configurable by parameters.

5.1.d Digital inputs



Digital inputs can be enabled by parameters.

Close pin "Dix" on pin "+V" to enable digital input.

It is possible to put in parallel the digital inputs of different devices joining together the 0V pins (9).

5.1.e Serial input

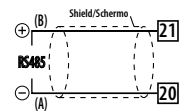

Modbus RS485 communication.
RTU Slave with galvanic insulation.

It is recommended to use the twisted and shielded cable for communications.

5.1.f Digital output

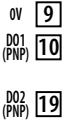

Digital output PNP (including SSR) for command or alarm.
Range 12 VDC/25 mA or 24 VDC/15mA selectable by parameter 282 $u.o.out$.

5.1.g Analogue output AO1



Linear output in mA or V (galvanically isolated) configurable as command, alarm or retransmission of process-setpoint.

The selection mA or Volt for the linear output depends on the parameters configuration.

5.1.h Relays output Q1 - Q2

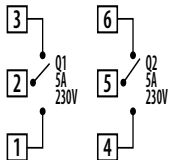

Capacity 5 A / 250 VAC for resistive loads.
See chart below.

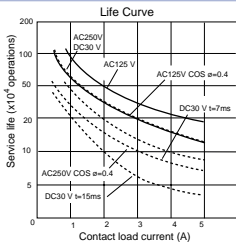

Electrical endurance Q1, Q2:

- 5A, 250 VAC, resistive loads, 10⁵ operations.
- 20/2A, 250 VAC, $\cos\phi = 0.3$, 10⁵ operations.

5.1.i Relay output Q3



Capacity 2 A / 250 VAC for resistive loads.
See chart below.

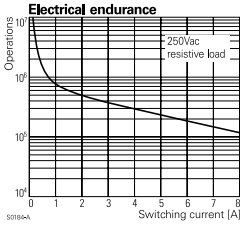

Electrical endurance Q3:

- 2A, 250 VAC, resistive loads, 10^5 operations.
- 20/2A, 250 VAC, $\cos\phi = 0.3$, 10^5 operations.





6 Display and Key Functions

	<p>1 1234</p>	<p>Normally displays the process. During the configuration phase, it displays the parameter being inserted.</p>
	<p>2 ProBE</p>	<p>Normally displays the setpoint. During the configuration phase, it displays the parameter value being inserted.</p>

6.1 Meaning of Status Lights (Led)

<p>3 C1</p>	<p>ON when the command output 1 is active. In versions with single analog input, it is ON when the valve is opening. In the versions with two analog inputs, in case of command 1 on the motorized valve, it is permanently ON when the valve is opening and flashing during the closing phase.</p>
<p>4 C2</p>	<p>ON when the command output 2 is active. In versions with single analog input, it is ON when the valve is opening. In the versions with two analog inputs, in case of command 2 on the motorized valve, it is permanently ON when the valve is opening and flashing during the closing phase.</p>
<p>5 A1</p>	<p>ON when alarm 1 is active.</p>
<p>6 A2</p>	<p>ON when alarm 2 is active.</p>
<p>7 A3</p>	<p>ON when alarm 3 is active.</p>
<p>8 TUN</p>	<p>ON when the controller is executing an auto-tuning cycle.</p>
<p>9 MAN</p>	<p>ON when "Manual" function is active.</p>
<p>10 REM</p>	<p>ON when the controller communicates through serial. Flashes when the remote setpoint is enabled.</p>



6.2 Keys

11		<ul style="list-style-type: none"> Increases the main setpoint. During configuration allows to scroll the parameters or the groups of parameters. Increases the setpoints.
12		<ul style="list-style-type: none"> Decreases the main setpoint. During configuration allows to scroll the parameters or the groups of parameters. Decreases the setpoints.
13	SET	<ul style="list-style-type: none"> Allows to visualize command and alarm setpoints. During configuration allows to enter the parameter to be modified and confirms the variation.
14	FNC	<ul style="list-style-type: none"> Allows to enter the Tuning launch function, automatic/manual selection. During configuration works as exit key (ESCAPE).
15		<ul style="list-style-type: none"> ON during the rising phase of the pre-programmed cycle;
		<ul style="list-style-type: none"> ON during the falling phase of the pre-programmed cycle;
		<ul style="list-style-type: none"> Both ON during parameter modification, when this is not a default value.

7 Controller Functions

7.1 Modification of main and alarm setpoint value

Setpoint value can be modified from keyboard as follows:

	Press	Display	Do
1		Value on display 2 changes.	Increases or decreases the main setpoint value.
2	SET	Visualizes the other setpoints on display 1. Display 2 shows the setpoint type.	
3		Value on display 1 changes.	Increases or decreases the alarm setpoint value.

7.2 Automatic Tune

Automatic tuning procedure allows a precise regulation without delving into the PID regulation algorithm. Selecting Auto on par. 73 *tun.1* (for the regulation loop 1), or on par. 98 *tun.2* (for the regulation loop 2), the controller analyzes the proces oscillations and optimizes the PID parameters. Led **TUN** flashes.

If the PID parameters are not yet selected, at the device switch-on, it is automatically launched the manual Tuning procedure described into the next paragraph.

7.3 Manual Tune

Manual procedure allows the user greater flexibility to decide when to update PID algorithm parameters. During the manual tuning, the device generates a step to analyze the system inertia to be regulated and, according to the collected data, modifies PID parameters.

After selecting *MAN* on par. 73 *tun.1*, or on par. 98 *tun.2*, the procedure can be activated in three ways:

- Running Tuning by keyboard:**
 Press **FNC** until display 2 shows *tunE* with display 1 on dis. and then press **SET**: display 1 shows *Enab*. Led **TUN** switches ON and the procedure starts.
- Running Tuning by digital input:**
 Select *tunE* on par. 231 *d.i.f.* (or on par. 239 *d.i.f.*). At first activation of digital input (commutation on front panel) led **TUN** led switches on and at second activation switches off.
- Running Tuning by serial input:**
 Write 1 on word modbus 1216 (command 1) or 1217 (command 2); led **TUN** switches ON and the procedure starts. Write 0 to stop the tuning.

To avoid an overshoot, the threshold where the controller calculates new PID parameters is determined by this operation:

Tune threshold = Setpoint - "Set Deviation Tune" (par. 74 5.d.t.1 or par. 99 5.d.t.2)

Ex.: if the setpoint is 100.0 °C and the Par.32 5.d.t.1 is 20.0 °C the threshold to calculate PID parameters is (100.0 - 20.0) = 80.0 °C.

For a greater precision on PID parameters calculation it is suggested to start the manual tuning procedure when the process deviates from the setpoint.

7.4 Tuning once

Set once on parameter 73 tun.1, or on parameter 98 tun.2.

Autotuning procedure is executed only once at next DRR244 restart. If the procedure doesn't work, will be executed at next restart.

7.5 Synchronized tuning

Set *Synch.* on parameter 73 tun.1 or on parameter 98 tun.2.

This procedure has been conceived to calculate correct PID values on multi-zone systems, where each temperature is influenced by the adjacent zones.

Writing on word modbus 1216 (for regulation loop 1) or 1217 (for regulation loop 2) the controller works as follows:

Word value	Action
0	Tune off
1	Command output OFF
2	Command output ON
3	Tune active
4	Tune completed: command output OFF (read only)
5	Tune not available: softstart function enabled (only reading)

Here below the functioning for regulation loop 1: the master switches-off or turns-on all zones (value 1 or 2 on word 1216) for a time long enough to create inertia on the system.

At this point the autotuning is launched (value 3 on word 1216). The controller executes the procedure for the calculation of the new PID values. When the procedure ends, the controller switches off the command output and selects the value 4 on word 1216. The master, who will always read the word 1216, will control the various zones and when all will have finished, will bring to 0 the value of word 1216: the various devices will regulate the temperature independently, with the new calculated values. N.B. The master must read the word 1216 at least every 10 seconds or the controller will automatically exit the autotuning procedure.

7.6 Digital input functions

The DRR244 functions related to digital inputs, can be enabled by parameters 231 d.i.1F. e 239 d.i.2F..

- 2E.5H.: Two threshold setpoint modification: with digital input active the DRR244 regulates on [SET2](#), otherwise regulates on [SET1](#);
- 2E.5H.1.: Modification of 2 setpoints by digital input with impulse command;
- 3E.5H.1.: Modification of 3 setpoints by digital input with impulse command,
- 4E.5H.1.: Modification of 4 setpoints by digital input with impulse command,
- 5E./5E.1.: Start / Stop of the controller by digital input with impulse command,
- RUN.: The regulation is enabled only with digital input active,
- Hold: With digital input active the conversion is locked (visualization maintenance function);
- LUNE: Enables/disables the Tuning if par. 73 tun.1 is selected as *MANU*;
- RUN.M.1.: If par. 48 R.M.1. is selected as *ENRB.* or *EN5E.*, with impulse command on digital input, the DRR244 switches the related regulation loop, from automatic to manual and vice versa.
- RUN.M.c.: If par. 48 R.M.1. is selected as *ENRB.* or *EN5E.* the DRR244 switches to manual the related regulation loop, with digital input active, otherwise the regulation is automatic.
- RCE.EF.: DRR244 execute a cooling type regulation with digital input active, otherwise the regulation is of heating type;

- **R.r. 0:** Zero tare function: brings the analogue input to 0.
- **M.RES.:** Allows the reset of the output if manual reset is active for the alarms and for the command outputs;
- **E.1.RUN:** If timer 1 is enabled (par. 328 EPr.1 different from d.5Ab), with digital input active, the timer is switched to RUN, otherwise is kept in STOP;
- **E.1.S.E.:** If timer 1 is enabled (par. 328 EPr.1 different from d.5Ab), acting on the digital input, the status of the timer switches from STOP to RUN e vice versa;
- **E.1.S.E.R.:** If il timer 1 is enabled (par. 328 EPr.1 different from d.5Ab), acting on the digital input, the timer is switched to RUN;
- **E.1.END:** If il timer 1 is enabled (par. 328 EPr.1 different from d.5Ab), acting on the digital input, the timer is switched to STOP;
- **E.2.RUN:** If timer 2 is enabled (par. 331 EPr.2 different from d.5Ab), with digital input active, the timer is switched to RUN, otherwise is kept in STOP;
- **E.2.S.E.:** If timer 2 is enabled (par. 331 EPr.2 different from d.5Ab), acting on the digital input, the status of the timer switches from STOP to RUN e vice versa;
- **E.2.S.E.R.:** If timer 2 is enabled (par. 331 EPr.2 different from d.5Ab), acting on the digital input, the timer is switched to RUN;
- **E.2.END:** If timer 2 is enabled (par. 331 EPr.2 different from d.5Ab), acting on the digital input, the timer is switched to STOP;
- **Ld.cFF.:** With digital input active, the access to setpoint configuration/modification is locked;
- **uP.KEY:** simulate button **A** operation;
- **down.K.:** simulate button **V** operation;
- **Fnc. K.:** simulate button **FNC** operation;
- **SEt. K.:** simulate button **SEt** operation;
- **E.t.AL:** External Alarm. The controller goes to STOP and the alarms are disabled. To return to START condition, one of following events is required:
 - switching off and on the controller
 - activation of the digital input if the relative parameter is 5t./5t.
 - by pressure **SEt** button if par. 286 s.k.s.f. set on 5t./5t.
 - START by serial commad on word modbus 1214).

7.7 Automatic / Manual regulation for % output control

This function allows to switch from automatic functioning to manual command of the output percentage.

With par. 48 PPr.1 it is possible to select two modes.

- 1 **First selection** (EnAb.) allows to enable with **FNC** the writing P:--- on display 1, while on display 2 is showed AutOn.

Press **SEt** to visualize PPr.1; it's now possible, during the process visualization, modify through the keys **A** and **V** the output percentage. To back to automatic, with the same procedure, select AutOn. on display 2: immediately led **MAN** switches off and functioning backs to automatic.

- 2 **Second selection** (EnSEt.) enables the same functioning but with two important variants:
 - If there is a temporary power failure or after switch-off, the manual functioning as well as the previous output percentage value will be maintained at restarting.
 - If the sensor breaks during automatic functioning, the controller switches to manual mode while maintaining the output percentage command unchanged as generated by the PID immediately before breakage.

Ex: on an extruder the command in percentage of the resistance (load) is maintained also in case of input sensor failure.

7.8 Heater Break Alarm on CT (Current Transformer)

This function allows to measure load current to manage an alarm during a malfunctioning with power in short circuit, always open or partial break of the charge. To enable this function set $50 H2$ or $60 H2$ on par. 287 $c.t.F.$ and the value of the connected transformer, on par. 288 $c.t.u.$.

- Select on par. 290 $H.b.R.t.$ the Heater Break Alarm intervention threshold in Ampere.
- Select on par. 291 $o.c.u.t.$ the intervention threshold in Ampere to control the overcurrent.
- Select on par. 292 $H.b.R.d.$ the delay time in seconds for the Heater Break Alarm intervention.
- It is possible to associate an alarm, selecting $H.b.R.$ on par. 123 $AL.I.F.$ on par. 141 $AL.2.F.$ or par. 159 $AL.3.F.$ or par. 177 $AL.4.F.$ or par. 195 $AL.5.F.$.

It is possible to visualize on display 2 the average current, selecting $AMP.Er.$ on par. 278 $u.i.d.2.$

Selecting 0 on par. 290 $H.b.R.t.$ it is possible to visualize the current consumption without generating an Heater Break Alarm.

7.9 Funzionamento in doppia azione (caldo-freddo)

DRR244 is suitable also for systems requiring a combined heating-cooling action.

The command output has to be configured as PID for Heating (Par. 38 $R.c.t.l = HEAT$ and $P.b.l$ greater than 0), and one of the alarms ($AL.I.F., AL.2.F., AL.3.F., AL.4.F., AL.5.F.$) has to be configured as $cool$.

The command output must be connected to the actuator responsible for heating, while the alarm will control cooling action.

Parameters to be configured for the heating PID are:

$R.c.t.l = HEAT$ Command output action type (Heating);

$P.b.l$: Heating proportional band;

$i.t.$: Integral time of heating and cooling;

$d.t.$: Derivative time of heating and cooling;

$c.t.$: Heating time cycle.

Parameters to be configured for the cooling PID related to regulation loop 1 and alarm 1 are:

$AL.I.F. = cool$. Alarm 1 selection (Cooling);

$P.b.l.t$: Proportional band multiplier;

$o.d.b.t$: Overlapping / Dead band;

$c.c.t.t$: Cooling time cycle.

Par. $P.b.l.t$ (that ranges from 1.00 to 5.00) determines the proportional band of cooling action basing on the formula:

Proportional band for cooling action = $P.b.l \times P.b.l.t$

This gives a proportional band for cooling which will be the same as heating band if $P.b.l.t = 1.00$, or 5 times greater if $P.b.l.t = 5.00$.

Integral and derivative time are the same for both actions.

Par. $o.d.b.t$ determines the percentage overlapping between the two actions. For systems in which the heating output and cooling output must never be simultaneously active a Dead Band ($o.d.b.t \leq 0$), must be configured, vice versa you can configure an overlapping ($o.d.b.t > 0$).

The following figure shows an example of dual action PID (heating-cooling) with $i.t. = 0$ e $d.t. = 0$.

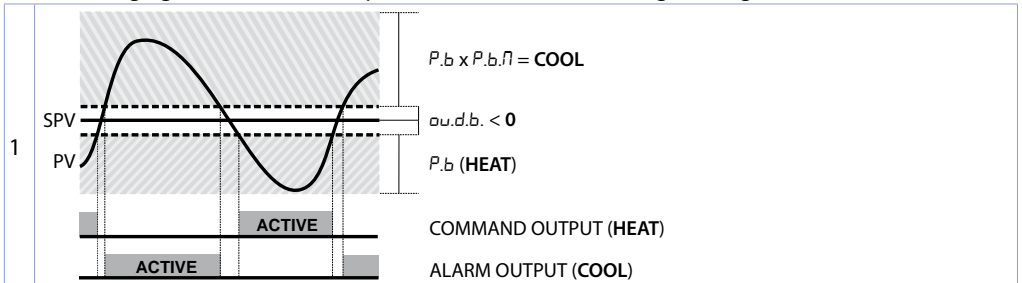

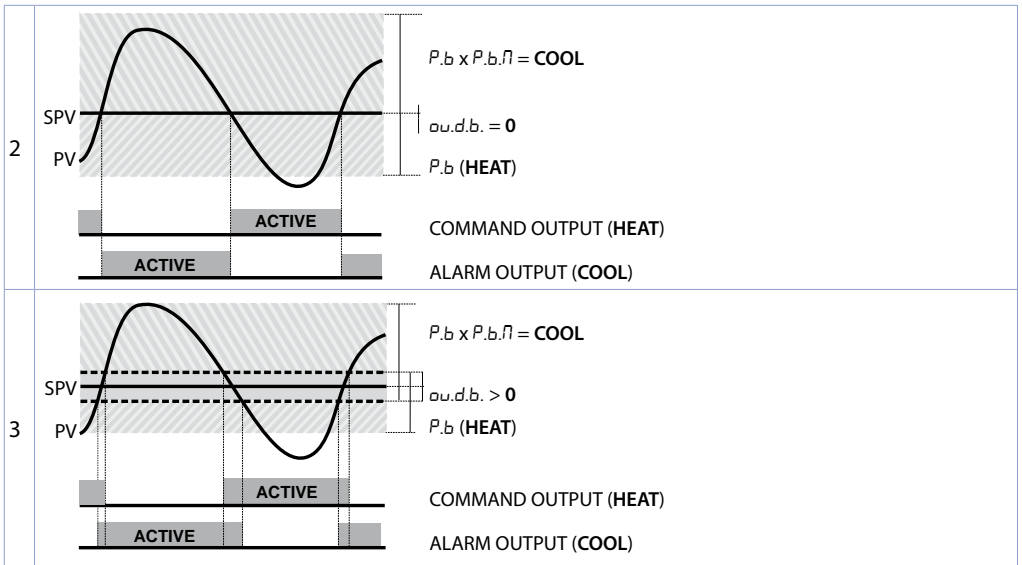

Parameter $c.c.t.i$ has the same meaning of cycle time for heating action $c.t.i$.

Parameter $co.F.i$ (Cooling Fluid) pre-selects the proportional band multiplier $P.b.n.i$ and the cooling PID cycle time $c.c.t.i$ according to cooling fluid type:

$co.F.i$	Cooling fluid type	$P.b.n.i$	$c.c.t.i$
Air	Air	1.00	10
oil	Oil	1.25	4
H_2O	Water	2.50	2

Once parameter $co.F.i$ has been selected, the parameters $P.b.n.i$, $\sigma_{u.d.b.}$ and $c.c.t.i$ can be however modified.

7.10 LATCH ON Function

For use with input $P_{o.t.}$ and with linear input (0..10 V, 0..40 mV, 0/4..20 mA) it is possible to associate start value of the scale (par. 4 $LL.i.i$) to the minimum position of the sensor and value of the scale end (par. 5 $UL.i.i$) to the maximum position of the sensor (par. 10 $Ltc.i$ configured as $Stndr$).

It is also possible to fix the point in which the controller will display 0 (however keeping the scale range between $LL.i.i$ and $UL.i.i$) using the "virtual zero" option by selecting $u.d.t.on$ or $u.d.t.off$ on par. 10 $Ltc.i$.

Selecting $u.d.t.on$, the virtual zero must be reset at each switching on; selecting $u.d.t.off$, the virtual zero will remain fixed once calibrated. To use the LATCH ON function, configure the par. $Ltc.i$.

Then refer to the following table for the calibration procedure:

	Press	Display	Do
1	FNC	Exit parameters configuration. Display 2 visualizes writing $LAtc$.	Place the sensor on minimum operating value (corresponding to $LL.i.i$)
2	✓	Store value on minimum. Display shows LoU .	Place sensor on maximum operating value (corresponding to $UL.i.i$).
3	▲	Store value on max. Display shows $HiGh$.	To exit standard proceeding press SET . For "virtual zero" setting, place the sensor to zero point.
4	FNC	Set virtual zero. Display shows $zEr0$. If "Virtual zero at start" is selected, point 4 must be repeated at each starting.	To exit procedure press SET .

1 The tuning procedure starts by exiting the configuration after changing the parameter.



7.11 Soft-Start Function

DRR244 is provided with two types of softstart selectable on parameter 264 *SS.TY* ("Softstart Type").

- 1 First selection (*GRAD*) enables gradient softstart. At starting the controller reaches setpoint basing on the rising gradient set on parameter 266 *SS.GR* ("Softstart Gradient") in Unit/hour (ex. °C/h). If parameter 269 *SS.TI* ("Softstart Time") is different to 0, at starting when the time selected on par. 269 is elapsed, the controller stops to follow the gradient and reaches setpoint with the maximum power.
- 2 Second selection (*PERC*) enables output percentual softstart. On par. 268 *SS.TH* it is possible to set the threshold under which starts the softstart ("Softstart Threshold"). On par. 267 *SS.PE* ("Softstart Percentage") an output percentage is selectable (from 0 to 100), which controller keeps until the process exceeds the threshold set on par. 268 or until the time in minutes set on par. 269 *SS.TI* ("Softstart Time" word 2084).

If the Sof-Start function is active the automatic/manual Tuning function cannot be activated.

7.12 Pre-Programmed cycle

Pre-programmed cycle function activates by setting *ENRB* on parameter 263 *PR.CY*.

Controller reaches setpoint 1 basing on the gradient set on parameter 266 *SS.GR*, then it reaches max. power up to setpoint 2. When the process reaches max. power, this setpoint is maintained for the time set on parameter 270 *PR.T.M*.

At expiry, process will reach ambient temperature according to gradient entered on parameter 271 *PR.GR*, then command output will be disabled and display will visualize *STOP*.

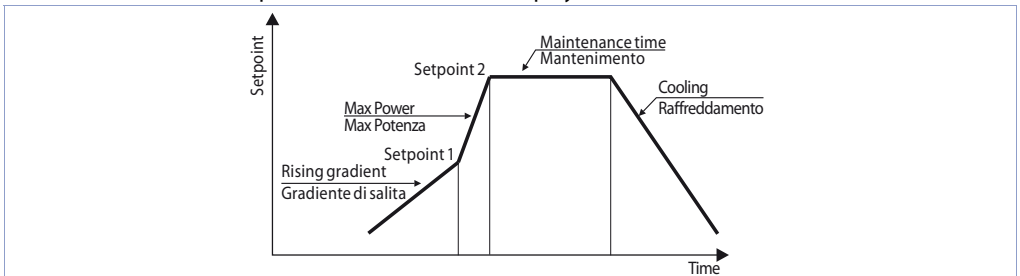

Cycle starts at each activation of the controller, or via digital input if it is enabled for this type of functioning (parameters 231, 239 set as *SE./SE.* or *PIH*).

7.13 Retransmission function on analogue output

If not used as command, the analogue output can be used to retransmit process/ setpoint/ current read by the C.T. input/ output percentage.

Select on parameter 298 *r.t.1* ("Retransmission 1") the value to be retransmitted and on parameter 299 *r.t.2* ("Retransmission 1 Type") the output type.

It is possible also to select on parameters 300 *r.l.l.* and 301 *r.l.u.l.* the input value rescale limites.

7.14 Timer functions

The DRR244 integrates two timers that can be independent, sequential or looped together.

Timer 1 is enabled on parameter 328 *t.r.1*; timer 2 on parameter 331 *t.r.2*:

- ENRb.* the timer starts from the keyboard or digital input (user intervention is required)
- EN.Sr.* the timer starts counting when the regulator is in RUN.

The timer time-base set in *00.55* or *hh.00* by changing parameters 329 *t.b.t.1* for timer 1 and 332 *t.b.t.2* for timer 2.

In parameter 334 *t.r.5.* can be define whether the timers should be independent or related to each other.

- SINGLE.* The timers work independently of each other.
- SEQU.E.* When timer 1 ends, timer 2 starts. The sequence is active only by starting timer 1. When timer 2 expires, the sequence is interrupted.
- LOOP* When a timer ends, another starts: the sequence repeats itself cyclically.

To change the duration of the counting time, follow the steps below:

	Press	Display	Do
1	SET	Press until <i>t.r.1</i> or <i>t.r.2</i> visualized on display 1.	
2	▲▼	Digits on display 1 changes.	Increase or decrease time value for the selected timer.

To start the keyboard count follow the steps below:

	Press	Display	Do
1	FNC	Press until <i>t.r.1</i> or <i>t.r.2</i> visualized on display 2. Display 1 shows STOP if the timer is stopped, otherwise it shows the remaining time.	
2	SET	The timer stops if active or starts counting if in STOP.	

Start/Stop of Timer is possible also by digital input (see parameters *d.i.1F* ... *d.i.4F.*)

The alarm outputs can be associated with the timers (parameters *AL.1F* ... *AL.5F*). On parameters 330 *AL.t.1* and 333 *AL.t.2* is possible to select the activation mode. The proposed solutions are as follows:

- SEARt.* Alarm active during timer counting
- ENd* Alarm active when the timer expiry
- WRRN.* Alarm active 5 " before the timer expiry

8 Serial communication

DRR244-13ABC-T is equipped with RS485 and can receive/broadcast data via serial communication using MODBUS RTU protocol. The device can only be configured as a Slave. This function enables the control of multiple controllers connected to a supervisory system / SCADA.

Each controller responds to a Master query only if the query contains the same address as parameter 318 *Sl.Ad.* ("Slave Address").

The addresses permitted range from 1 to 254 and there must not be controllers with the same address on the same line.

Address 255 can be used by the Master to communicate with all the connected equipment (broadcast mode), while with 0 all the devices receive the command, but no response is expected.

The baud rate is selected on parameter 319 *bd.rt.* ("Baud Rate").

DRR244 can introduce a delay (in milliseconds) of the response to the master request. This delay must be set on parameter 321 *SE.dE.* ("Serial Delay").

Each parameter modification is saved by the controller in the EEPROM memory (100000 writing cycles), while the setpoints are saved with a delay of 10 seconds after the last modification.

Changes made to words that are different from those reported in the following table can lead to malfunction.

Modbus RTU protocol features	
Baud-rate	Selectable on parameter 319 <i>bd.rt.</i> 1200bit/s 28800bit/s 2400bit/s 38400bit/s 4800bit/s 57600bit/s 9600bit/s 115200bit/s 19200bit/s
Format	Selectable on parameter 320 <i>S.P.P.</i> 8N1 8N2 8E1 8E2 8O1 8O2
Supported functions	WORD READING (max 50 word) (0x03, 0x04) SINGLE WORD WRITING (0x06) MULTIPLE WORDS WRITING (max 50 word) (0x10)

Here below a list of all available addresses and supported functions:

RO = Read Only	R/W = Read/Write	WO = Write Only
----------------	------------------	-----------------

Modbus address	Description	Read Write	Reset value
0	Device type	RO	474
1	Software version	RO	Flash
2	Boot version	RO	Flash
3	Slave Address	RO	Eepr/dip
6	Baud rate	RO	Eepr/dip
50	Slave address automatic learning	WO	-
51	System code comparison for slave address automatic learning	WO	-
500	Loading default values (write 9999)	RW	0
501	Restart DRR244 (write 9999)	RW	0
502	Setpoint storing delay time	RW	10
503	Parameters storing delay time	RW	1
701	First character of the custom alarm message 1	RW	"u"
...			
723	Last character of the custom alarm message 1	RW	0
751	First character of the custom alarm message 2	RW	"u"
...			

Modbus address	Description	Read Write	Reset value
773	Last character of the custom alarm message 2	RW	0
801	First character of the custom alarm message 3	RW	"u"
...			
823	Last character of the custom alarm message 3	RW	0
851	First character of the custom alarm message 4	RW	"u"
...			
873	Last character of the custom alarm message 4	RW	0
901	First character of the custom alarm message 5	RW	"u"
...			
923	Last character of the custom alarm message 5	RW	0
951	First character of the custom alarm message 6	RW	"u"
...			
973	Last character of the custom alarm message 6	RW	0
1000	AI1 value (degrees with tenth)	RO	-
1006	Real setpoint (gradient) of the regulation loop 1	RO	0
1008	Alarms status (0=absent, 1=present) Bit0 = Alarm 1 Bit3 = Alarm 4 Bit1 = Alarm 2 Bit4 = Alarm 5 Bit2 = Alarm 3 Bit5 = Alarm 6	RO	0
1009	Error flags 1 Bit0 = AI1 process error (sensor 1) Bit1 = Reserved Bit2 = Cold junction error Bit3 = Safety error Bit4 = Generic error Bit5 = Hardware error Bit6 = Error H.B.A. (partial ropture of the load) Bit7 = Error H.B.A. (SSR in short circuit) Bit8 = Overcurrent error Bit9 = Parameters out of range error Bit10= CPU eeprom writing error Bit11= RFid eeprom writing error Bit12= CPU eeprom reading error Bit13= RFid eeprom reading error Bit14= Eeprom calibrations bench corrupted Bit15= Eeprom constants bench corrupted	RO	0
1010	Error flags 2 Bit0 = Missing calibrations error Bit1 = Eeprom CPU bench parameters corrupted Bit2 = Eeprom CPU setpoint bench corrupted Bit3 = RFid memory not formatted	RO	0
1011	Digital inputs status (0=not active, 1=active) Bit0 = Digital inp. 1 Bit1 = Digital inp. 2	RO	0
1012	Outputs status (0=off, 1=on) Bit 0 = Q1 Bit 3 = DO1 Bit 1 = Q2 Bit 4 = DO2 Bit 2 = Q3	RO	0

Modbus address	Description	Read Write	Reset value
1013	Stato led (0=OFF, 1=ON) Bit 0 = Led UP ▲ Bit 6 = Led TUN Bit 1 = Led C1 Bit 7 = Led point time 2 Bit 2 = Led C2 Bit 8 = Led MAN Bit 3 = Led A1 Bit 9 = Led REM Bit 4 = Led A2 Bit 10 = Led DOWN arrow Bit 5 = Led A3 Bit 11 = Led point time 1	RO	0
1014	Key status (0=released, 1=pressed) Bit 0 = Key UP arrow Bit 2 = Key FNC Bit 1 = Key DOWN arrow Bit 3 = Key SET	RO	0
1015	Cold junction temperature (degrees with tenth)	RO	-
1016	Current CT istantaneous (Ampere with tenth)	RO	0
1017	Current CT average (Ampere with tenth)	RO	0
1018	Current CT ON (Ampere with tenth)	RO	0
1019	Current CT OFF (Ampere with tenth)	RO	0
1100	AI1 value with decimal point selection	RO	-
1106	Real setpoint (gradient) of the regulation loop 1 with decimal point selection	RO	0
1200	Setpoint 1 of regulation loop 1 (degrees with tenth)	R/W	EEPROM
1201	Setpoint 2 of regulation loop 1 (degrees with tenth)	R/W	EEPROM
1202	Setpoint 3 of regulation loop 1 (degrees with tenth)	R/W	EEPROM
1203	Setpoint 4 of regulation loop 1 (degrees with tenth)	R/W	EEPROM
1208	Alarm 1 setpoint (degrees with tenth) Alarm 1 upper setpoint if Par. 123 $RL.1.F. = R.bRNd$	R/W	EEPROM
1209	Alarm 2 setpoint (degrees with tenth) Alarm 2 upper setpoint if Par. 141 $RL.2.F. = R.bRNd$	R/W	EEPROM
1210	Alarm 3 setpoint (degrees with tenth) Alarm 3 upper setpoint if Par. 159 $RL.3.F. = R.bRNd$	R/W	EEPROM
1211	Alarm 4 setpoint (degrees with tenth) Alarm 4 upper setpoint if Par. 177 $RL.4.F. = R.bRNd$	R/W	EEPROM
1212	Alarm 5 setpoint (degrees with tenth) Alarm 5 upper setpoint if Par. 195 $RL.5.F. = R.bRNd$	R/W	EEPROM
1214	Start/Stop 0=controller in STOP 1=controller in START	R/W	0
1215	Hold conversion ON/OFF 0=Hold conversion OFF 1=Hold conversion ON	R/W	0
1216	Tune management for regulation loop 1 With automatic Tune (par. 73 $t_{un.1} = R_{uT0}$): 0=autotuning function OFF 1=autotuning ON	RO	0
	With manual Tune (par. 73 $t_{un.1} = P_{RNU}$ or Q_{ncE}): 0=autotuning function OFF 1=autotuning ON	R/W	0
	With synchronized Tune (par. 73 $t_{un.1} = S_{ynch}$): 0=autotuning function OFF 1=command output OFF (forces the cooling) 2=command output ON (forces the heating) 3=autotuning ON 4=autotuning ended	R/W	0

Modbus address	Description	Read Write	Reset value
1218	Automatic/manual selection for regulation loop 1 0=automatic; 1=manual	R/W	0
1220	Command output percentage for regulation loop 1 (0-10000) Heating output percentage with regulation 1 in double loop (0-10000)	R/W	0
1221	Command output percentage for regulation loop 1 (0-1000) Heating output percentage with regulation 1 in double loop (0-1000)	R/W	0
1222	Command output percentage for regulation loop 1 (0-100) Heating output percentage with regulation 1 in double loop (0-100)	R/W	0
1223	Cooling output percentage with regulation 1 in double loop (0-10000)	RO	0
1224	Cooling output percentage with regulation 1 in double loop (0-1000)	RO	0
1225	Cooling output percentage with regulation 1 in double loop (0-100)	RO	0
1232	Command output manual reset for regulation loop 1: write 0 to reset the command output. In reading 0=reset not allowed, 1=reset allowed	R/W	0
1233	Alarms manual reset: write 0 to reset all alarms. In reading 0=reset not allowed, 1=reset allowed Bit0 = Alarm 1 Bit3 = Alarm 4 Bit1 = Alarm 2 Bit4 = Alarm 5 Bit2 = Alarm 3	R/W	0
1235	Alarm 1 remote stauts (0=absent, 1=present)	R/W	0
1236	Alarm 2 remote stauts (0=absent, 1=present)	R/W	0
1237	Alarm 3 remote stauts (0=absent, 1=present)	R/W	0
1238	Alarm 4 remote stauts (0=absent, 1=present)	R/W	0
1239	Alarm 5 remote stauts (0=absent, 1=present)	R/W	0
1241	Value AO1 by serial (Par. 298 $rL.i.F. = Rd.bu5$)	R/W	0
1243	Tara di zero AI1 (1=tare; 2=reset tare)	R/W	0
1249	Value of remote setpoint by command 1 serial	R/W	0
1251	Alarm 1 lower setpoint if Par. 123 $R.L.i.F. = R.bRNd$ (degrees with tenth)	R/W	EEPROM
1252	Alarm 2 lower setpoint if Par. 141 $R.L.z.F. = R.bRNd$ (degrees with tenth)	R/W	EEPROM
1253	Alarm 3 lower setpoint if Par. 159 $R.L.z.F. = R.bRNd$ (degrees with tenth)	R/W	EEPROM
1254	Alarm 4 lower setpoint if 177 $R.L.y.F. = R.bRNd$ (degrees with tenth)	R/W	EEPROM
1255	Alarm 5 lower setpoint if Par. 195 $R.L.y.F. = R.bRNd$ (degrees with tenth)	R/W	EEPROM
1300	Setpoint 1 of regulation loop 1, with decimal point selection	R/W	EEPROM
1301	Setpoint 2 of regulation loop 1, with decimal point selection	R/W	EEPROM
1302	Setpoint 3 of regulation loop 1, with decimal point selection	R/W	EEPROM
1303	Setpoint 4 of regulation loop 1, with decimal point selection	R/W	EEPROM
1308	Alarm 1 setpoint, with decimal point selection Alarm 1 upper setpoint if Par. 123 $R.L.i.F. = R.bRNd$	R/W	EEPROM
1309	Alarm 2 setpoint, with decimal point selection Alarm 2 upper setpoint if Par. 141 $R.L.z.F. = R.bRNd$	R/W	EEPROM
1310	Alarm 3 setpoint, with decimal point selection Alarm 3 upper setpoint if Par. 159 $R.L.z.F. = R.bRNd$	R/W	EEPROM
1311	Alarm 4 setpoint, with decimal point selection Alarm 4 upper setpoint if Par. 177 $R.L.y.F. = R.bRNd$	R/W	EEPROM
1312	Alarm 5 setpoint, with decimal point selection Alarm 5 upper setpoint if Par. 195 $R.L.y.F. = R.bRNd$	R/W	EEPROM
1351	Alarm 1 lower setpoint if Par. 123 $R.L.i.F. = R.bRNd$, with decimal point selection	R/W	EEPROM
1352	Alarm 2 lower setpoint if Par. 141 $R.L.z.F. = R.bRNd$, with decimal point selection	R/W	EEPROM
1353	Alarm 3 lower setpoint if Par. 159 $R.L.z.F. = R.bRNd$, with decimal point selection	R/W	EEPROM

Modbus address	Description	Read Write	Reset value
1354	Alarm 4 lower setpoint if Par. 177 <i>RL.4.F.</i> = <i>R.bAnd</i> , with decimal point selection	R/W	EEPROM
1355	Alarm 5 lower setpoint if Par. 195 <i>RL.5.F.</i> = <i>R.bAnd</i> , with decimal point selection	R/W	EEPROM
2001	Parameter 1	R/W	EEPROM
2002	Parameter 2	R/W	EEPROM
...	Parameter ...	R/W	EEPROM
2366	Parameter 366	R/W	EEPROM

9 Reading and configuration through NFC





Programmable
by RFID /NFC.
No wiring required!



Scan the Qr-Code
to download the App
on Google Play Store®

The controller DRR244 is supported by the App MyPixsys: using an ANDROID smartphone with NFC connection it is possible to program the device without using a dedicated equipment. The App allows to read, set and backup all parameters which are stored into the internal memory of Pixsys devices.

Procedure:

- Identify the position of the NFC antenna on the smartphone (usually behind the back cover) or to one of the sides in case of metal chassis. The DRR244's antenna is placed on the frontal panel, between the function keys.
- Make sure that the NFC sensor of the phone is enabled or that there are no metal materials between the phone and the device (ex. aluminium cover or with magnetic stand)
- It is useful to enable the system sounds on the smartphone, as the notification sound confirms that the device has correctly been detected.

The App interface is provided with four tabs: SCAN, DATA, WRITE, EXTRA.

Select the first tab "SCAN" to read data stored into the internal memory of the device; place the smartphone in contact with the controller frontal panel, making sure that the phone's antenna matched with that of the controller.

Once detected the device, the App emits a notification sounds and proceeds with the model identification and the reading of the parameters.

The graphic interface shows the advancement and switches to the second tab "DATA". It is now possible to move the smartphone away from the controller to make the required modifications more easily.









The device parameters are divided into collapsible groups and are displayed with name, current value and reference index to the manual.

Click on a row to open the setting screen of the related parameter with the detailed view of available options (in case of multiple choice parameters) or of the minimum/maximum/decimals limits (for numeric parameters), included the text description (as per section n. 11 of the user manual). Once selected the chosen value, the related row will be updated and underlined into the tab "DATA" (hold down the line to cancel modifications).

To download the new configuration on your device, select the third tab "WRITE", place again the smartphone in contact with the controller and wait for the notification.



The DRR244 will show a restart request, necessary to update the configuration with the new written modifications; if it does not restart, the DRR244 will continue to work with the previous configuration. In addition to the classic operation of parameters reading->modification->writing, MyPixsys is provided with additional functions which can be accessed by the tab "EXTRA", as save parameters / e-mail loaded values/ restore default values.

10 Access configuration

	Press	Display	Do
1	FNC for 3 sec.	Display 1 shows <i>PRSS</i> , while display 2 shows <i>0000</i> with the 1st digit flashing.	
2	 	Modify flashing digit and move to next digit with SET .	Enter password <i>1234</i> .
3	FNC to confirm	Display 1 shows the first parameters group, display 2 shows the description.	
4	 or 	Scroll parameters groups.	
5	SET to confirm	Display 1 shows the first parameter of the group and display 2 shows its value.	Press FNC to exit configuration.
6	 or 	Scroll parameters.	
7	SET to confirm	Allows parameter modification (display 2 flashes)	
8	 or 	Increases or decreases visualized value	Introduce new data
9	SET	Confirms and stores the new value. If the value is different from default values, the arrow keys light on.	
10	FNC	Backs to parameter groups selection (see point 3).	Press again FNC to exit configuration

10.1 Loading default values

This procedure allows to restore factory settings of the device.

	Press	Display	Do
1	FNC for 3 sec	Display 1 shows <i>PRSS</i> , while display 2 shows <i>0000</i> with the 1st digit flashing.	
2	 or 	Modify the flashing digit and move to the next one pressing SET .	Enter password <i>9999</i> .
3	FNC to confirm	The device loads default settings and restarts.	

10.2 Parameters list functioning

The controller DRR244 integrates many features that make the configuration parameters list very long. To make it more functional, the parameters list is dynamics and it changes as the user enables / disables the functions. Practically, using a specific function that occupies a given input (or output), the parameters referred to other functions of that resource are hidden to the user making the parameters list more concise.

To simplify the reading/interpretation of the parameters, pressing **SET** it is possible to visualize a brief description of the selected parameter.

Finally, keeping pressed **FNC**, it is possible to move from the mnemonic visualization of the parameter to the numeric one, and vice versa. Ex. The first parameter can be displayed as *SEn.1* (mnemonic visualization) or as *PODI* (numeric visualization).

Set the product parameters so that they are suitable for the system to be controlled. If they are not suitable, unexpected operations may occasionally cause materials damage or accidents.

11 Table of Configuration Parameters

GROUP A - *Fl.in.1* - Analogue input 1

1	<i>SEn.1</i>	Sensor AI1
Analogue input configuration / sensor AI1 selection		
<i>tc. K</i>	Tc-K	-260° C..1360° C. (Default)
<i>tc. S</i>	Tc-S	-40° C..1760° C
<i>tc. R</i>	Tc-R	-40° C..1760° C
<i>tc. J</i>	Tc-J	-200° C..1200° C
<i>tc. t</i>	Tc-T	-260° C..400° C
<i>tc. E</i>	Tc-E	-260° C..980° C
<i>tc. N</i>	Tc-N	-260° C..1280° C
<i>tc. b</i>	Tc-B	100° C..1820° C
<i>Pt100</i>	Pt100	-200° C..600° C
<i>Ni100</i>	Ni100	-60° C..180° C
<i>Ntc 1</i>	NTC 10K β 3435K	-40° C..125° C
<i>Ptc</i>	PTC 1K	-50° C..150° C
<i>Pt500</i>	Pt500	-200° C..600° C
<i>Pt1k</i>	Pt1000	-200° C..600° C
<i>0-1</i>	0..1 V	
<i>0-5</i>	0..5 V	
<i>0-10</i>	0..10 V	
<i>0-20</i>	0..20 mA	
<i>4-20</i>	4..20 mA	
<i>0-60</i>	0..60 mV	
<i>Pot.</i>	Potentiometer (set the value on parameter 6)	
<i>Ni120</i>	Ni120	-60° C..240° C
<i>Ntc 2</i>	NTC 10K β 3694K	-40° C..150° C
<i>Ntc 3</i>	NTC 2252 β 3976K	-40° C..150° C

2	<i>dP. 1</i>	Decimal Point 1
Select number of displayed decimal points for AI1		
	Default	
<i>0</i>	1 decimale	
<i>0.00</i>	2 decimali	
<i>0.0000</i>	3 decimali	

3	<i>dEGr.</i>	Degree
<i>°C</i>	Celsius (Default)	
<i>°F</i>	Fahrenheit	
<i>K</i>	Kelvin	

- 4** *LL.L* **Lower Linear Input AI1**
AI1 lower limit only for linear signals. Ex.: with input 4..20 mA this parameter takes value associated to 4 mA. The value may be greater than the one entered on the next parameter.
-9999..+30000 [digit^{1/p.54}] **Default:** 0.
- 5** *UL.L* **Upper Linear Input AI1**
AI1 upper limit only for linear signals Ex: with input 4..20 mA this parameter takes value associated to 20 mA. The value may be lower than the one entered on the previous parameter.
-9999..+30000 [digit^{1/p.54}] **Default:**1000
- 6** *P.UR.I* **Potentiometer Value AI1**
Selects the value of the potentiometer connected on AI1
1..150 kohm. Default: 10kohm
- 7** *i.O.L.I* **Linear Input over Limits AI1**
If AI1 is a linear input, allows to the process to overpass the limits (parameters 4 and 5).
d.SRb. Disabled (**Default**)
ENRb. Enabled
- 8** *o.c.R.I* **Offset Calibration AI1**
AI1 Offset calibration. Value added/subtracted to the process value (ex: usually correcting the ambient temperature value).
-9999..+9999 [digit^{1/p.54}] (degrees.tenths for temperature sensors). **Default** 0.
- 9** *G.c.R.I* **Gain Calibration AI1**
Value multiplied to the process value to calibrate the working point. Ex: to correct the range from 0..1000°C showing 0..1010°C, set the parameter to -1.0
-100.0%...+100.0%, **Default:** 0.0.
- 10** *Lt.c.I* **Latch-On AI1**
Automatic setting of limits for AI1 linear input
d.SRb. Disabled (**Default**)
StMRd Standard
V.O.Sto. Virtual Zero Stored
V.O.E.oN. Virtual Zero at start
- 11** *c.F.L.I* **Conversion Filter AI1**
ADC Filter: Number of sensor readings to calculate mean that defines process value. **NB:** When readings increase, control loop speed slows down. 1...15. (**Default:** 10)
- 12** *c.Fr.I* **Conversion Frequency AI1**
Sampling frequency of digital / analogue converter for AI1. Increasing the conversion speed will slow down reading stability
(example: for fast transients, as the pressure, it is advisable to increase sampling frequency).
- | | | | |
|----------------|--|---------------|--------------------------------|
| <i>4.17.HZ</i> | 4.17 Hz (Min. conversion speed) | <i>33.2HZ</i> | 33.2 Hz |
| <i>6.25HZ</i> | 6.25 Hz | <i>39.0HZ</i> | 39.0 Hz |
| <i>8.33HZ</i> | 8.33 Hz | <i>50.0HZ</i> | 50.0 Hz |
| <i>10.0HZ</i> | 10.0 Hz | <i>62.0HZ</i> | 62.0 Hz |
| <i>12.5HZ</i> | 12.5 Hz | <i>123HZ</i> | 123 Hz |
| <i>16.7HZ</i> | 16.7 Hz (Default) Ideal for noises filtering 50 / 60 Hz | <i>242HZ</i> | 242 Hz |
| <i>19.6HZ</i> | 19.6 Hz | <i>470HZ</i> | 470 Hz (Max. speed conversion) |

13 *L.c.E.1* Lower Current Error 1

If AI1 is a 4-20 mA input, it determines the current value below the probe error E-05 is signaled.

2.0 mA	(Default)	2.6 mA	3.2 mA	3.8 mA
2.2 mA		2.8 mA	3.4 mA	
2.4 mA		3.0 mA	3.6 mA	

14÷17 Reserved Parameters - Group A

Reserved parameters - Group A

GROUP B - *rES.* - Reserved

18÷34 Reserved Parameters - Group B

Reserved parameters - Group B

GROUP C - *cPd.1* - Outputs and regulation Process 1

35 *c.o.u.1* Command Output 1

Selects the command output related to the process1 and the outputs related to the alarms.

- c. o2* Command on relay output Q2.
- c. o1* Command on relay output Q1. (Default)
- c. SSR* Command on digital output
- c. VRL.* Servo-valve command with open loop on Q1 and Q2 relays
- c. 0-10* Command 0-10 V on analogue output AO1.
- c.4-20* Command 4-20 mA on analogue output AO1.
- 0.10.S.P.* Command 0-10 V on analogue output AO1 with split-range function: the analogue output sets the cooling action from 0 to 5V and heating action from 5 to 10V.
- 4.20.S.P.* Command 4-20 mA on analogue output AO1 with split-range function: the analogue output sets the cooling action from 4 to 12mA and heating action from 12 to 20mA.
- c. VRL.c.* Servo-valve command with open loop on Q2 and Q3 relays

	Command	AL. 1	AL. 2	AL. 3	AL. 4	AL. 5
<i>c. o2</i>	Q2	Q1	Q3	DO1	DO2	AO1
<i>c. o1</i>	Q1	Q2	Q3	DO1	DO2	AO1
<i>c. SSR</i>	DO1	Q1	Q2	Q3	DO2	AO1
<i>c. VRL.</i>	Q1(open) Q2(close)	Q3	DO1	DO2	AO1	-
<i>c. 0-10 (0.10.S.P.)</i>	AO1 (0..10 V)	Q1	Q2	Q3	DO1	DO2
<i>c.4-20 (4.20.S.P.)</i>	AO1 (4..20 mA)	Q1	Q2	Q3	DO1	DO2
<i>c. VRL.c.</i>	Q2(open) Q3(close)	Q1	DO1	DO2	AO1	-

NB: if an output is used for functions other than alarms (for example retransmission or command n° 2), this resource will no longer be available as an alarm and the related group will be hidden from the parameter list. The correspondence of the functions/outputs remains however that indicated in the tables above.

36 *rES.* Reserved

Reserved parameter

37 *rES.* Reserved

Reserved parameter

38 *Ac.t.1* Action type 1

Action type to control process 1.

- HELE* Heating (N.A.) (Default)
- COOL* Cooling (N.C.)

39 *c.HY.1* Command Hysteresis 1

Hysteresis to control process 1 in ON/OFF.

-9999..+9999 [digit^{1/0..5/1}] (degrees.tenths for temperature sensors). **Default** 0.2.

40 *LLS.1* Lower Limit Setpoint 1

Lower limit setpoint selectable for command setpoint 1.
-9999..+30000 [digit^{1 p.54}] (degrees.tenths for temperature sensors). **Default 0.**

41 *ULS.1* Upper Limit Setpoint 1

Upper limit setpoint selectable for command setpoint 1.
-9999..+30000 [digit^{1 p.54}] (degrees for temperature sensors). **Default 1750.**

42 *c.r.E.1* Command Reset 1

Type of reset for command contact 1 (always automatic in P.I.D. functioning)

R. RES. Automatic Reset (**Default**)

M. RES. Manual Reset (by keyboard or by digital input)

M.RES.S. Manual Reset Stored (keeps relay status also after an eventual power failure)

R.RES.L. Automatic reset with timed activation. The command remains active for the time set on the parameter 45 *c.dE.1.*, even if the conditions generating it are missing. To be able to act again, the conditions for activating the command must disappear.

43 *c.S.E.1* Command State Error 1

State of contact for command 1 output in case of error.

If the command output 1 (Par. 35 *c.O.V.1*) is relay or valve:

oPEN Contact or valve open. **Default**

cLoSE Contact or valve closed.

If the command output 1 is digital output (SSR):

oFF Digital output OFF. **Default**

oN Digital output ON.

If the command output 1 is 0-10V:

0 V 0 V. **Default**

10 V 10 V.

If the command output 1 is 0-20 mA or 4-20 mA:

0 mA 0 mA. **Default**

4 mA 4 mA.

20 mA 20 mA.

21.5mA 21.5 mA.

44 *c.L.d.1* Command Led 1

Defines led C1 state corresponding to the relevant output. If the valve command is selected, this parameter is not managed.

o.c. ON with open contact or SSR switched off. If command AO1, ON with output 0%, OFF if 100% and flashing between 1% and 99%.

c.c. ON with closed contact or SSR switched on. If command AO1 ON with output 100%, OFF if 0% and flashing between 1% and 99%. (**Default**)

45 *c.dE.1* Command Delay 1

Command 1 delay (only in ON / OFF functioning).

-60:00..60:00 mm:ss. **Default: 00:00.**

Negative: delay when turning off output.

Positive: delay when turning on output.

46 *c.S.P.1* Command Setpoint Protection 1

Allows or not to modify command setpoint 1 value

FREE Modification allowed (**Default**)

LoCK Protected

- 47** *Valve Time 1* **Valve Time 1**
 Valve time related to command 1 (declared by the manufacturer of the valve)
 1...300 seconds. **Default:** 60.
- 48** *Automatic / Manual 1* **Automatic / Manual 1**
 Enables the automatic/manual selection for command 1
dSRb. Disabled (**Default**)
ENRb. Enabled
ENSto. Enabled with memory
- 49** *Initial State* **Initial State**
 Choose the state of the controller when turning it on. This only works on the RS485 version or by enabling the Start/Stop from digital input or **S3I** button.
StRRt Start (**Default**)
StoP Stop
StoPE. Stored. State of Start/Stop prior to switching off.
- 50** *State Valve Saturation* **State Valve Saturation**
 Select the valve status when the output percentage is 100%
PERc. The valve opening relay is activated for a time equal to 5% of the valve time
FxEd The valve opening relay is always active
- 51÷53** **Reserved Parameters - Group C**
 Reserved parameters - Group C
- GROUP D - rES. - Reserved**
- 54÷72** **Reserved Parameters - Group D**
 Reserved parameters - Group D
- GROUP E - rEL.1 - Autotuning and PID 1**
- 73** *Tune 1* **Tune 1**
 Selects autotuning type for command 1
dSRb. Disabled. If proportional band and integral time paramters are to selected to zero, the regulation is ON/OFF type.. (**Default**)
Autto Automatic (Automatic P.I.D. parameters calculation)
MANU. Manual (launch by keyboards or by digital input)
oMCE Once (P.I.D. parameters calculation only at first start)
SYNcH. Synchronized (Autotuning managed by serial)
- 74** *Setpoint Deviation Tune 1* **Setpoint Deviation Tune 1**
 Selects deviation from command setpoint 1 as threshold used by autotuning to calculate P.I.D. parameters
 0-10000 [digit^{1p.5d}] (degrees.tenths for temp. sensors). **Default:** 30.0.
- 75** *Proportional Band 1* **Proportional Band 1**
 Proportional band or process 1 P.I.D. regulation (Process inertia).
 0 ON / OFF if t.i. equal to 0 (**Default**)
 1...10000 [digit^{1p.5d}] (degrees.tenths for temp. sensors).
- 76** *Integral Time 1* **Integral Time 1**
 Integral time for process 1 P.I.D. regulation (process inertia duration).
 0.0...2000.0 secondi (0.0 = integral disabled), **Default** 0.0

77 *d.t. 1* **Derivative Time 1**

Derivative time for process 1 P.I.D. regulation (Normally ¼ of integral time).
0.0...1000.0 secondi (0.0 = derivative disabled), **Default 0**

78 *d.b. 1* **Dead Band 1**

Dead band of process 1 P.I.D..
0...10000 [digit^{1 p.54}] (degrees.tenths for temp. sensors) (**Default: 0**)

79 *P.b.c.1* **Proportional Band Centered 1**

Defines if the proportional band 1 must be centered or not on the setpoint. In double loop functioning (heating/cooling), always disabled.

d.5Rb. Disabled. Band under (heating) or over (cooling)(**Default**)

ENRb. Centered band

80 *o.o.5.1* **Off Over Setpoint 1**

In P.I.D. enables the command output 1 switching off, when a certain threshold is exceeded (setpoint + Par.81)

d.5Rb. Disabled (**Default**)

ENRb. Enabled

81 *o.d.t.1* **Off Deviation Threshold 1**

Selects deviation from command setpoint 1, to calculate the intervention threshold of "Off Over Setpoint 1" function.

-9999...+9999 [digit^{1 p.54}] (degrees.tenths for temp. sensors) (**Default: 0**)

82 *c.t. 1* **Cycle Time 1**

Cycle time for P.I.D. regulation of process 1 (for P.I.D. on remote control switch 15 s; for PID on SSR 2s). For valve refer to parameter *47 uR.t.1*

1-300 seconds (**Default:15 s**)

83 *co.F.1* **Cooling Fluid 1**

Type of refrigerant fluid for heating / cooling P.I.D. for process 1. Enable the cooling output on parameter AL.1 .. AL.6.

R.R Air (**Default**)

o.L Oil

WRtEP Water

84 *P.b.M.1* **Proportional Band Multiplier 1**

Proportional band multiplier for heating/cooling P.I.D. for process 1. Proportional band for cooling action is given by parameter *P.b. 1* multiplied for this value

1.00...5.00. **Default: 1.00**

85 *o.d.b.1* **Overlap / Dead Band 1**

Dead band combination for heating / cooling P.I.D. (double action) for process 1.

-20.0%...50.0%

Negative: Dead band.

Positive: overlap. **Default: 0.0%**

86 *c.c.t.1* **Cooling Cycle Time 1**

Cycle time for cooling output in hating/cooling P.I.D. mode for process 1.

1-300 seconds (**Default:10 s**)

87 *LLP.1* **Lower Limit Output Percentage 1**

Selects min. value for command output 1 percentage.

0%...100%, **Default: 0%**.

88 *u.L.P.1* **Upper Limit Output Percentage 1**

Selects max. value for command output 1 percentage.
0%...100%, **Default:** 100%.

89 *P.G.T.1* **Max Gap Tune 1**

Selects the max. process-setpoint gap beyond which the automatic tune recalculates PID parameters of process 1.
0-10000 [digit^{10.54}] (degrees.tenths for temp. sensors). **Default:** 2.0

90 *P.P.1* **Minimum Proportional Band 1**

Selects the min. proportional band 1 value selectable by the automatic tune for the P.I.D. regulation of process 1.
0-10000 [digit^{10.54}] (degrees.tenths for temp. sensors). **Default:** 3.0

91 *P.P.1* **Maximum Proportional Band 1**

Selects the max. proportional band 1 value selectable by the automatic tune for the P.I.D. regulation of process 1.
0-10000 [digit^{10.54}] (degrees.tenths for temp. sensors). **Default:** 80.0

92 *P.I.1* **Minimum Integral Time 1**

Selects the min. integral time 1 value selectable by the automatic tune for the P.I.D. regulation of process 1.
0.0...1000.0 seconds. **Default:** 30.0 s.

93 *O.C.L.1* **Overshoot Control Level 1**

The overshoot control function prevents this event during device switching on or when the setpoint is modified.

Setting a too low value the overshoot may not be fully absorbed, while with high values the process could reach the setpoint more slowly.

Disab.	Lev. 3	Lev. 6	Lev. 9
Lev. 1	Lev. 4	Lev. 7	Lev. 10
Lev. 2	Lev. 5 (Default)	Lev. 8	

94÷97 **Reserved Parameters - Group E**

Reserved parameters - Group E

GROUP F - rE5. - Reserved

98÷122 **Reserved Parameters - Group F**

Reserved parameters - Group F

GROUP G - *AL*. 1 - ALARM 1

123 *AL*.1.F. Alarm 1 Function

Alarm 1 selection.

d.5*AB*. Disabled (**Default**)

AB.*u*.*P*.*R*. Absolute Upper Activation. Absolute referred to the process, active over

AB.*L*.*O*.*R*. Absolute Lower Activation. Absolute referred to the process, active under

*b**AND*. Band alarm (command setpoint ± alarm setpoint)

u.*P*.*d**EV*. Upper Deviation alarm

L.*O*.*d**EV*. Lower Deviation alarm

AB.*c*.*u*.*R*. Absolute Command Upper Activation. Absolute alarm referred to the command setpoint, active over

AB.*c*.*L*.*R*. Absolute Command Lower Activation. Absolute alarm referred to the command setpoint, active under

*R**UN*. Status alarm (active in RUN/START)

*c**ool*. Cold actuator auxiliary (Cold action in double loop)

*PP**b*.*ER*. Probe error. Alarm active in case of sensor ropture.

*t**MP*.1 Related to timer 1

*t**MP*.2 Related to timer 2

*t**MP*.1.2 Related to both timers

REM. Remote. The alarm is enabled by the word 1235

d.1.1 Digital Input 1. Active when digital input 1 is active.

d.1.2 Digital Input 2. Active when digital input 2 is active.

H.*b*.*R*. Heater Break Alarm and Overcurrent Alarm

A.*b**AND*. Asymmetric band alarm (command setpoint + alarm setpoint 1 H and command setpoint - alarm setpoint 1 L).

c. *R**ux* Auxiliary for job distribution on the command output. It cyclically replaces the command output for the time set on the parameter 134 *R*.*l*.*d**E*.. See *R*.*l*.*d**E*. = 0, it is activated parallel to the command output. It does not work in case of valve control and can only be activated on an alarm if *R*.*l*.*d**E*. is different from 0.

124 *r**ES*. Reserved

Reserved parameter

125 *r**ES*. Reserved

Reserved parameter

126 *A**J*.*S*.*O*. Alarm 1 State Output

Alarm 1 output contact and intervention type.

N.*O*. 5*E*. (N.O. Start) Normally open, active at start (**Default**)

N.*C*. 5*E*. (N.C. Start) Normally closed, active at start

N.*O*. *t**H*. (N.O. Threshold) Normally open, active on reaching alarm^{2 p.54}

N.*C*. *t**H*. (N.C. Threshold) Normally closed, active on reaching alarm^{2 p.54}

N.*O*. *t**H*.*V*. (N.O. Threshold Variation) disabled after changing control setpoint^{3 p.54}

N.*C*. *t**H*.*V*. (N.C. Threshold Variation) disabled after changing control setpoint^{3 p.54}

127 *r**ES*. Reserved

Reserved parameter.

128 *A*.*HY*. Alarm 1 Hysteresis

Alarm 1 hysteresis

-9999..+9999 [digit^{1 p.54}] (degrees for temp. sensors). **Default** 0.5.

129 *A*.*LL*. Alarm 1 Lower Limit

Lower limit selectable for the alarm 1 setpoint.

-9999..+30000 [digit^{1 p.54}] (degrees for temp. sensors). **Default** 0.

130 *R.L.U.L.* Alarm 1 Upper Limit

Upper limit selectable for the alarm 1 setpoint
-9999..+30000 [digit^{1 p.54}] (degrees for temp. sensors). **Default** 1750.

131 *R.L.r.E.* Alarm 1 Reset

Alarm 1 contact reset type (always automatic if AL.1.F. = c. Aux).

R. RES. Automatic reset (**Default**)

M. RES. Manual reset (manual reset by keyboard or by digital input)

M.RES.5. Stored manual reset (keeps the output status also after a power failure)

R. RES.t. Automatic reset with timed activation. The alarm remains active for the time set on the parameter 134 *R. l.dE.*, even if the conditions generating it are missing. To be able to act again, the alarm conditions must disappear.

132 *R.l.S.E.* Alarm 1 State Error

Alarm 1 output status in case of error.

aPEN Open contact. **Default**

cLoSE Closed contact.

133 *R.l.L.d.* Alarm 1 Led

Defines the status of the led **A1** in correspondence of the relevant output

a.c. ON with open contact or DO switched off.

c.c. ON with closed contact or DO switched on. (**Default**)

134 *R.l.dE.* Alarm 1 Delay

Alarm 1 Delay.

-60:00..60:00 mm:ss (hh:mm if *R.L. l.F.* = c. *R.u**). **Default**: 00:00.

Negative value: delay when exit alarm status.

Positive value: delay when enter alarm status.

135 *R.l.S.P.* Alarm 1 Setpoint Protection

Allows or not to change the alarm 1 setpoint

FREE Editable by the user (**Default**)

Lock Protected

Hide Protected and not visualized

136 *R.l.L.b.* Alarm 1 Label

Selects the message displayed in case of alarm 1 intervention.

d.5Rb. Disabled. (**Default**) 0.

Lb. 01 Message 1 (see table on paragraph 11.1)

...

Lb. 16 Message 16 (see table on paragraph 11.1)

USER.L. Custom message (modifiable by the user through the App or via modbus)

137÷140 Reserved Parameters - Group G

Reserved parameters - Group G

GROUP H - *AL. 2* - ALARM 2

141 *AL.2.F.* Alarm 2 Function

Alarm 2 selection.

d.5Rb. Disabled (**Default**)

Rb.u.P.R. Absolute Upper Activation. Absolute referred to the process, active over

Rb.L.o.R. Absolute Lower Activation. Absolute referred to the process, active under

bRNd Band alarm (command setpoint ± alarm setpoint)

u.P.dEV. Upper Deviation alarm

L.o.dEV. Lower Deviation alarm

Rb.c.u.R. Absolute Command Upper Activation. Absolute alarm referred to the command setpoint, active over

Rb.c.L.R. Absolute Command Lower Activation. Absolute alarm referred to the command setpoint, active under

RuN Status alarm (active in RUN/START)

cooL Cold actuator auxiliary (Cold action in double loop)

PPb.ER. Probe error. Alarm active in case of sensor ropture.

EMR.1 Related to timer 1

EMR.2 Related to timer 2

EMR.1.2 Related to both timers

REM. Remote. The alarm is enabled by the word 1236

d.i. 1 Digital Input 1. Active when digital input 1 is active.

d.i. 2 Digital Input 2. Active when digital input 2 is active.

H.b.R. Heater Break Alarm and Overcurrent Alarm

R.bRNd Asymmetric band alarm (command setpoint + alarm setpoint 2 H and command setpoint - alarm setpoint 2 L).

*c. Ru** Auxiliary for job distribution on the command output. It cyclically replaces the command output for the time set on the parameter 152 *R.2.dE.*. If *R.2.dE.* = 0, it is activated parallel to the command output. It does not work in case of valve control and can only be activated on an alarm if *R.2.dE.* is different from 0.

142 *rES.* Reserved

Reserved parameter

143 *rES.* Reserved

Reserved parameter

144 *R.2S.o.* Alarm 2 State Output

Alarm 2 output contact and intervention type.

N.o. 5E. (N.O. Start) Normally open, active at start (**Default**)

N.c. 5E. (N.C. Start) Normally closed, active at start

N.o. 5H. (N.O. Threshold) Normally open, active on reaching alarm^{2 p.54}

N.c. 5H. (N.C. Threshold) Normally closed, active on reaching alarm^{2 p.54}

N.o. 5H.V. (N.O. Threshold Variation) disabled after changing control setpoint^{3 p.54}

N.c. 5H.V. (N.C. Threshold Variation) disabled after changing control setpoint^{3 p.54}

145 *rES.* Reserved

Reserved parameter.

146 *R.2HY.* Alarm 2 Hysteresis

Alarm 2 hysteresis

-9999..+9999 [digit^{1 p.54}] (degrees for temp. sensors). **Default** 0.5.

147 *R.2LL.* Alarm 2 Lower Limit

Lower limit selectable for the alarm 2 setpoint.

-9999..+30000 [digit^{1 p.54}] (degrees for temp. sensors). **Default** 0.

148 *R2.U.L.* Alarm 2 Upper Limit

Upper limit selectable for the alarm 2 setpoint
-9999..+30000 [digit^{1 p.54}] (degrees for temp. sensors). **Default** 1750.

149 *R2.r.E.* Alarm 2 Reset

Alarm 2 contact reset type (always automatic if *R.L.z.F.* = *c. R.u.z*).

R. RES. Automatic reset (**Default**)

M. RES. Manual reset (manual reset by keyboard or by digital input)

M.RES.5. Stored manual reset (keeps the output status also after a power failure)

R. RES.t. Automatic reset with timed activation. The alarm remains active for the time set on the parameter 152 *R.z.dE.*, even if the conditions generating it are missing. To be able to act again, the alarm conditions must disappear.

150 *R25.E.* Alarm 2 State Error

Alarm 2 output status in case of error

If the alarm output is relay

aPEN Contact or open valve. **Default** *cLo5E* Contact or closed valve.

If the alarm output is digital (SSR):

aFF Digital output OFF. **Default** *aH* Digital output ON.

151 *R2Ld.* Alarm 2 Led

Defines the status of the led **A2** in correspondence of the relevant output.

a.c. ON with open contact or DO switched off.

c.c. ON with closed contact or DO switched on. (**Default**)

152 *R.z.dE.* Alarm 2 Delay

Alarm 2 Delay. -60:00..60:00 mm:ss (hh:mm if *R.L.z.F.* = *c. R.u.z*). **Default**: 00:00.

Negative value: delay when exit alarm status.

Positive value: delay when enter alarm status

153 *R25.P.* Alarm 2 Setpoint Protection

Allows or not to change the alarm 2 setpoint

FREE Editable by the user (**Default**)

LoCK Protected

Hi.dE Protected and not visualized

154 *R2Lb.* Alarm 2 Label

Selects the message displayed in case of alarm 2 intervention.

d.SRb. Disabled. (**Default**) 0.

Lb. 01 Message 1 (see table on paragraph 11.1)

..

Lb. 20 Message 20 (see table on paragraph 11.1)

uSER.L. Custom message (modifiable by the user through the App or via modbus)

155÷158 Reserved Parameters - Group H

Reserved parameters - Group H

GROUP I - AL 3 - ALARM 3

159 *AL3.F.* Alarm 3 Function

Alarm 3 selection.

d.5Rb. Disabled (**Default**)

Rb.u.P.R. Absolute Upper Activation. Absolute referred to the process, active over

Rb.Lo.R. Absolute Lower Activation. Absolute referred to the process, active under

bRNd Band alarm (command setpoint ± alarm setpoint)

u.P.dEV. Upper Deviation alarm

Lo.dEV. Lower Deviation alarm

Rb.c.u.R. Absolute Command Upper Activation. Absolute alarm referred to the command setpoint, active over

Rb.c.L.R. Absolute Command Lower Activation. Absolute alarm referred to the command setpoint, active under

RuN Status alarm (active in RUN/START)

cooL Cold actuator auxiliary (Cold action in double loop)

PPb.ER. Probe error. Alarm active in case of sensor rupture.

EMR.1 Related to timer 1

EMR.2 Related to timer 2

EMR.1.2 Related to both timers

REM. Remote. The alarm is enabled by the word 1237

d.i. 1 Digital Input 1. Active when digital input 1 is active.

d.i. 2 Digital Input 2. Active when digital input 2 is active.

H.b.R. Heater Break Alarm e Overcurrent Alarm

R.bRNd Asymmetric band alarm (command setpoint + alarm setpoint 3 H and command setpoint - alarm setpoint 3 L).

*c. Ru** Auxiliary for job distribution on the command output. It cyclically replaces the command output for the time set on the parameter 170 *R.3.dE.* If *R.3.dE.* = 0, it is activated parallel to the command output. It does not work in case of valve control and can only be activated on an alarm if *R.3.dE.* is different from 0.

160 *rES.* Reserved

Reserved parameter

161 *rES.* Reserved

Reserved parameter

162 *AS.o.* Alarm 3 State Output

Alarm 3 output contact and intervention type.

N.o. 5E. (N.O. Start) Normally open, active at start (**Default**)

N.c. 5E. (N.C. Start) Normally closed, active at start

N.o. 5H. (N.O. Threshold) Normally open, active on reaching alarm^{2 p.54}

N.c. 5H. (N.C. Threshold) Normally closed, active on reaching alarm^{2 p.54}

N.o. 5H.V. (N.O. Threshold Variation) disabled after changing control setpoint^{3 p.54}

N.c. 5H.V. (N.C. Threshold Variation) disabled after changing control setpoint^{3 p.54}

163 *AO.o.t.* Alarm 3 Output Type

Defines the output type if the alarm 3 is analogue.

O.10 V Output 0...10 V. **Default**

4.20mA Output 4...20 mA.

164 *AS.H.* Alarm 3 Hysteresis

Alarm 3 hysteresis.

-9999..+9999 [digit^{1 p.54}] (degrees for temp. sensors). **Default** 0.5.

165 *ALLL* Alarm 3 Lower Limit

Lower limit selectable for the alarm 3 setpoint.
-9999..+30000 [digit^{1 p.54}] (degrees for temp. sensors). **Default 0.**

166 *ALUL* Alarm 3 Upper Limit

Upper limit selectable for the alarm 3 setpoint
-9999..+30000 [digit^{1 p.54}] (degrees for temp. sensors). **Default 1750.**

167 *ALRE* Alarm 3 Reset

Alarm 3 contact reset type (always automatic if *RL.F.F. = c. Rux*).

R.PES. Automatic reset (**Default**)

M.PES. Manual reset (manual reset by keyboard or by digital input)

M.PES.S. Stored manual reset (keeps the output status also after a power failure)

R.PES.t. Automatic reset with timed activation. The alarm remains active for the time set on the parameter 170 *R.dE.*, even if the conditions generating it are missing. To be able to act again, the alarm conditions must disappear.

168 *ALSE* Alarm 3 State Error

Alarm 3 output status in case of error.

If the alarm output is relay

aPEN Contact or open valve. **Default**

cLoSE Contact or closed valve.

If the alarm output is digital (SSR):

aFF Digital output OFF. **Default**

aH Digital output ON.

If the alarm output is 0-10V:

0 V 0 V. **Default**

10 V 10 V.

If the alarm output is 0-20 mA or 4-20 mA:

0 mA 0 mA. **Default**

20 mA 20 mA.

4 mA 4 mA.

21.5 mA 21.5 mA.

169 *ALd.* Alarm 3 Led

Defines the status of the led **A3** in correspondence of the relevant output.

a.c. ON with open contact, DO switched off or AO deactivated.

c.c. ON with closed contact, DO switched on or AO activated. (**Default**)

170 *ALdE.* Alarm 3 Delay

Alarm 3 Delay.

-60:00..60:00 mm:ss (hh:mm if *RL.F.F. = c. Rux*). **Default: 00:00.**

Negative value: delay when exit alarm status.

Positive value: delay when enter alarm status

171 *ALSP.* Alarm 3 Setpoint Protection

Allows or not to change the alarm 3 setpoint.

FREE Editable by the user (**Default**)

LoCK Protected

HiDE Protected and not visualized

172 *ALLb.* Alarm 3 Label

Selects the message displayed in case of alarm 3 intervention.

dISEAb. Disabled. (**Default**) 0.

Lb. 01 Message 1 (see table on paragraph 11.1) ...

Lb. 20 Message 20 (see table on paragraph 11.1)

uSER.L. Custom message (modifiable by the user through the App or via modbus)

173÷176 Reserved Parameters - Group I

Reserved parameters - Group I

GROUP J - AL. 4 - ALARM 4

177 *AL4.F.* Alarm 4 Function

Alarm 4 selection.

d.5Rb. Disabled (**Default**)

Rb.u.P.R. Absolute Upper Activation. Absolute referred to the process, active over

Rb.Lo.R. Absolute Lower Activation. Absolute referred to the process, active under

bRNd Band alarm (command setpoint \pm alarm setpoint)

u.P.dEV. Upper Deviation alarm

Lo.dEV. Lower Deviation alarm

Rb.c.u.R. Absolute Command Upper Activation. Absolute alarm referred to the command setpoint, active over

Rb.c.L.R. Absolute Command Lower Activation. Absolute alarm referred to the command setpoint, active under.

RuN Status alarm (active in RUN/START)

cooL Cold actuator auxiliary (Cold action in double loop)

PPb.ER. Probe error. Alarm active in case of sensor ropture.

EMR.1 Related to timer 1

EMR.2 Related to timer 2

EMR.1.2 Related to both timers

REM. Remote. The alarm is enabled by the word 1238

d.i. 1 Digital Input 1. Active when digital input 1 is active.

d.i. 2 Digital Input 2. Active when digital input 2 is active.

H.b.R. Heater Break Alarm and Overcurrent Alarm

R.bRNd Asymmetric band alarm (command setpoint + alarm setpoint 4 H and command setpoint - alarm setpoint 4 L).

*c. Ru** Auxiliary for job distribution on the command output. It cyclically replaces the command output for the time set on the parameter 188 *R.Y.dE.* If *R.Y.dE.* = 0, it is activated parallel to the command output. It does not work in case of valve control and can only be activated on an alarm if *R.Y.dE.* is different from 0.

178 *rES.* Reserved

Reserved parameter

179 *rES.* Reserved

Reserved parameter

180 *AL5.o.* Alarm 4 State Output

Alarm 4 output contact and intervention type.

N.o. 5E. (N.O. Start) Normally open, active at start (**Default**)

N.c. 5E. (N.C. Start) Normally closed, active at start

N.o. tH. (N.O. Threshold) Normally open, active on reaching alarm^{2 p.54}

N.c. tH. (N.C. Threshold) Normally closed, active on reaching alarm^{2 p.54}

N.o. tH.V. (N.O. Threshold Variation) disabled after changing control setpoint^{3 p.54}

N.c. tH.V. (N.C. Threshold Variation) disabled after changing control setpoint^{3 p.54}

181 *AL.o.t.* Alarm 4 Output Type

Defines the output type if the alarm 4 is analogue.

0.10 V Output 0...10 V. **Default**

4.20mA Output 4...20 mA.

182 *AL4.HY.* Alarm 4 Hysteresis

Alarm 4 hysteresis.

-9999.+9999 [digit^{1 p.54}] (degrees for temp. sensors). **Default** 0.5.

183 *ALLL* **Alarm 4 Lower Limit**

Lower limit selectable for the alarm 4 setpoint.
 -9999..+30000 [digit^{1 p.54}] (gradi per sensori di temperatura). **Default 0.**

184 *ALUL* **Alarm 4 Upper Limit**

Upper limit selectable for the alarm 4 setpoint.
 -9999..+30000 [digit^{1 p.54}] (degrees for temp. sensors). **Default 1750.**

185 *ALRE* **Alarm 4 Reset**

Alarm 4 contact reset type (always automatic if *ALCF* = *c. ALU*).

RES Automatic reset (**Default**)

MRES Manual reset (manual reset by keyboard or by digital input)

MRES.S Stored manual reset (keeps the output status also after a power failure)

RES.L Automatic reset with timed activation. The alarm remains active for the time set on the parameter 188 *ALDE*., even if the conditions generating it are missing. To be able to act again, the alarm conditions must disappear.

186 *ALSE* **Alarm 4 State Error**

Alarm 4 output status in case of error.

If the alarm output is digital (SSR):

<i>OFF</i>	Digital output OFF. Default	<i>ON</i>	Digital output ON.
------------	------------------------------------	-----------	--------------------

If the alarm output is 0-10V:

<i>0V</i>	0 V. Default	<i>10V</i>	10 V.
-----------	---------------------	------------	-------

If the alarm output is 0-20 mA or 4-20 mA:

<i>0mA</i>	0 mA. Default	<i>20mA</i>	20 mA.
<i>4mA</i>	4 mA.	<i>21.5mA</i>	21.5 mA.

187 *RES* **Reserved**

Reserved parameter

188 *ALDE* **Alarm 4 Delay**

Alarm 4 Delay.

-60:00..60:00 mm:ss (hh:mm if *ALCF* = *c. ALU*). **Default: 00:00.**

Negative value: delay when exit alarm status.

Positive value: delay when enter alarm status

189 *ALSP* **Alarm 4 Setpoint Protection**

Allows or not to change the alarm 4 setpoint.

FREE Editable by the user (**Default**)

LOCK Protected

HIDE Protected and not visualized

190 *ALLB* **Alarm 4 Label**

Selects the message displayed in case of alarm 4 intervention.

DISAB Disabled. (**Default**) 0.

Lb. 01 Message 1 (see table on paragraph 11.1) ..

Lb. 20 Message 20 (see table on paragraph 11.1)

USER.L Custom message (modifiable by the user through the App or via modbus)

191÷194 **Reserved Parameters - Group J**

Reserved parameters - Group J

GROUP K - *RL 5* - Allarme 5 (solo su DRR244-13ABC e DRR244-23XX-T)

195 *RLS.F.* Alarm 5 Function

Alarm 5 selection 5.

d.5Rb. Disabled (**Default**)

Rb.u.P.R. Absolute Upper Activation. Absolute referred to the process, active over

Rb.Lo.R. Absolute Lower Activation. Absolute referred to the process, active under

bRNd Band alarm (command setpoint ± alarm setpoint)

u.P.dEV. Upper Deviation alarm

Lo.dEV. Lower Deviation alarm

Rb.c.u.R. Absolute Command Upper Activation. Absolute alarm referred to the command setpoint, active over.

Rb.c.L.R. Absolute Command Lower Activation. Absolute alarm referred to the command setpoint, active under

RuN Status alarm (active in RUN/START)

cooL Cold actuator auxiliary (Cold action in double loop)

PPb.ER. Probe error. Alarm active in case of sensor ropture.

EMR.1 Related to timer 1

EMR.2 Related to timer 2

EMR.1.2 Related to both timers

REM. Remote. The alarm is enabled by the word 1239

d.i. 1 Digital Input 1. Active when digital input 1 is active.

d.i. 2 Digital Input 2. Active when digital input 2 is active.

H.b.R. Heater Break Alarm and Overcurrent Alarm

R.bRNd Asymmetric band alarm (command setpoint + alarm setpoint 5 H and command setpoint - alarm setpoint 5 L).

*c. Ru** Auxiliary for job distribution on the command output. It cyclically replaces the command output for the time set on the parameter 206 *R.5.dE.* If *R.5.dE.* = 0, it is activated parallel to the command output. It does not work in case of valve control and can only be activated on an alarm if *R.5.dE.* is different from 0.

196 *rES.* Reserved

Reserved parameter

197 *rES.* Reserved

Reserved parameter

198 *ASS.o.* Alarm 5 State Output

Contatto uscita allarme 5 e tipo intervento.

N.o. 5E. (N.O. Start) Normally open, active at start (**Default**)

N.c. 5E. (N.C. Start) Normally closed, active at start

N.o. 5H. (N.O. Threshold) Normally open, active on reaching alarm^{2 p. 54}

N.c. 5H. (N.C. Threshold) Normally closed, active on reaching alarm^{2 p. 54}

N.o. 5H.V. (N.O. Threshold Variation) disabled after changing control setpoint^{3 p. 54}

N.c. 5H.V. (N.C. Threshold Variation) disabled after changing control setpoint^{3 p. 54}

199 *RS.o.t.* Alarm 5 Output Type

Defines the output type if the alarm 5 is analogue.

B.10 V Output 0...10 V. **Default**

4.20mA Output 4...20 mA.

200 *RS.HY.* Alarm 5 Hysteresis

Alarm 5 hysteresis.

-9999.+9999 [digit^{1 p. 54}] (degrees for temp. sensors). **Default** 0.5.

201 *RSLL* Alarm 5 Lower Limit

Lower limit selectable for the alarm 5 setpoint.
-9999..+30000 [digit^{1 p.54}] (degrees for temp. sensors). **Default 0.**

202 *RSUL* Alarm 5 Upper Limit

Upper limit selectable for the alarm 5 setpoint.
-9999..+30000 [digit^{1 p.54}] (degrees for temp. sensors). **Default 1750.**

203 *RSrE* Alarm 5 Reset

Alarm 5 contact reset type (always automatic if *RL.S.F. = c. RAu**).

R. RES. Automatic reset (**Default**)

M. RES. Manual reset (manual reset by keyboard or by digital input)

M.RES.S. Stored manual reset (keeps the output status also after a power failure)

R. RES.t. Automatic reset with timed activation. The alarm remains active for the time set on the parameter 206 *R.S.dE.*, even if the conditions generating it are missing. To be able to act again, the alarm conditions must disappear.

204 *RSE.E* Alarm 5 State Error

Alarm 5 output status in case of error.

If the alarm output is digital (SSR):

oFF Digital output OFF. **Default** *oN* Digital output ON.

If the alarm output is 0-10V:

0 V 0 V. **Default** *10 V* 10 V.

If the alarm output is 0-20 mA or 4-20 mA:

0 mA 0 mA. **Default** *20 mA* 20 mA.

4 mA 4 mA. *21.5mA* 21.5 mA.

205 *rES.* Reserved

Reserved parameter

206 *RS.dE.* Alarm 5 Delay

Alarm 5 Delay.

-60:00..60:00 mm:ss (hh:mm if *RL.S.F. = c. RAu**). **Default: 00:00.**

Negative value: delay when exit alarm status.

Positive value: delay when enter alarm status

207 *RSS.P.* Alarm 5 Setpoint Protection

Allows or not to change the alarm 5 setpoint.

FPEE Editable by the user (**Default**)

LoCK Protected

Hi.dE Protected and not visualized

208 *RSLb.* Alarm 5 Label

Selects the message displayed in case of alarm 5 intervention.

d.SRb. Disabled. (**Default**) 0.

Lb. 01 Message 1 (see table on paragraph 11.1)

..

Lb. 20 Message 20 (see table on paragraph 11.1)

uSER.L. Custom message (modifiable by the user through the App or via modbus)

209÷212 Reserved Parameters - Group K

Reserved parameters - Group K

GROUP L - rES - Reserved

213÷230 Reserved Parameters - Group L

Reserved parameters - Group L

GROUP M - d.i. 1 - Digital input 1

231 d.i.F. Digital Input 1 Function

Digital input 1 functioning.

d.SRb. Disabled (**Default**)

zE. SM. 2 Setpoints Switch

zE.SM.i. 2 Setpoints Switch Impulsive

3E.SM.i. 3 Setpoints Switch Impulsive

4E.SM.i. 4 Setpoints Switch Impulsive

SE./SE. Start / Stop

RuN Run

HoLd Lock conversion (stop all conversions and display values)

tUNE Performing manual tune

Ru.MR.i. Automatic / Manual Impulse (if enabled on parameter 48 or 67)

Ru.MR.c. Automatic / Manual Contact (if enabled on parameter 48 or 67)

RcE.tY. Action Type. Cooling regulat. if D.I. is active, otherwise heating reg.

R.i. 0 Analogue Input 0. Set AI to zero

M. RES. Manual reset. Reset the outputs if selected as manual reset.

t.1.RuN Timer 1 run. The timer 1 count with activated D.I.

t.1. SE. Timer 1 Start End. D.I. starts and stops the timer 1(impulsive)

t.1. SE.R. Timer 1 Start. D.I. starts the timer 1(impulsive)

t.1. ENd Timer 1 End. D.I. stops the timer 1(impulsive)

t.2.RuN Timer 2 run. The timer 2 count with activated D.I.

t.2. SE. Timer 2 Start End. D.I. starts and stops the timer 2(impulsive)

t.2. SE.R. Timer 2 Start. D.I. starts the timer 2(impulsive)

t.2. ENd Timer 2 End. D.I. stops the timer 2(impulsive)

Lo.cFG. Lock configuration and setpoints.

uP.KEY Simulates the functioning of up key.

dOWN.K. Simulates the functioning of down key.

Fnc. K. Simulates the functioning of fnd key.

SEt. K. Simulates the functioning of set key.

Ext.AL. External alarm. The controller goes on STOP and the alarms will be disabled. The controller does not return to START automatically: for this operation, the user's intervention is required.

232 d.i.c. Digital Input 1 Contact

Defines the resting contact of the digital input 1.

N.oPEN Normally open (**Default**)

N.cLoS. Normally closed

233÷238 Reserved Parameters - Group M

Reserved parameters - Group M

GROUP N - d. i. 2 - Digital input 2

239 d. i. 2.F. Digital Input 2 Function

Digital input 2 functioning.

d.i.SRb. Disabled (**Default**)

2E. SM. 2 Setpoints Switch

2E. SM. i. 2 Setpoints Switch Impulsive

3E. SM. i. 3 Setpoints Switch Impulsive

4E. SM. i. 4 Setpoints Switch Impulsive

5E. /5E. Start / Stop

RuN Run

HoLd Lock conversion (stop all conversions and display values)

tUNE Performing manual tune

Au.MR. i. Automatic / Manual Impulse (if enabled on parameter 48 or 67)

Au.MR. c. Automatic / Manual Contact (if enabled on parameter 48 or 67)

ActE. tY. Action Type. Cooling regulation if D.I. is active, otherwise heating reg.

R. i. 0 Analogue Input 0. Set AI to zero

M. RES. Manual reset. Reset the outputs if selected as manual reset.

t. 1. RuN. Timer 1 run. The timer 1 count with activated D.I.

t. 1. SE. Timer 1 Start End. D.I. starts and stops the timer 1(impulsive)

t. 1. SEr. Timer 1 Start. D.I. starts the timer 1(impulsive)

t. 1. ENd. Timer 1 End. D.I. stops the timer 1(impulsive)

t. 2. RuN. Timer 2 run. The timer 2 count with activated D.I.

t. 2. SE. Timer 2 Start End. D.I. starts and stops the timer 2(impulsive)

t. 2. SEr. Timer 2 Start. D.I. starts the timer 2(impulsive)

t. 2. ENd. Timer 2 End. D.I. stops the timer 2(impulsive)

Lo. cFG. Lock configuration and setpoints.

uP. KEy. Simulates the functioning of up key.

dowN. K. Simulates the functioning of down key.

Fnc. K. Simulates the functioning of fnc key.

SEt. K. Simulates the functioning of set key.

Ext. RL. External alarm. The controller goes on STOP and the alarms will be disabled. The controller does not return to START automatically: for this operation, the user's intervention is required.

240 d. i. 2.c. Digital Input 2 Contact

Defines the resting contact of the digital input 2.

N. oPEN. Normally open (**Default**)

N. cLoS. Normally closed

241÷246 Reserved Parameters - Group N

Reserved parameters - Group N

GROUP O - rE5. - Reserved

247÷254 Reserved Parameters - Group O

Reserved parameters - Group O

GROUP P - rE5. - Reserved

255÷262 Reserved Parameters - Group P

Reserved parameters - Group P

GROUP Q - 5F.E.5 - Soft-start and mini cycle

263 Pr.cY. Pre-programmed Cycle

Enables special functionings.

d:SRb. Disabled (**Default**)

ENRb. Enabled (all remote setpoint functions are inhibited)

264 5SEY. Soft-Start Type

Enables and selects the soft-start type

d:SRb. Disabled (**Default**)

GRPd. Gradient

PERc. Percentage (only with pre-programmed cycle disabled)

265 rES. Reserved

Reserved parameter

266 5SGr. Soft-Start Gradient

Rising/falling gradient for soft-start and pre-programmed cycle.

0..20000 Digit/ora (gradi.decimo/ora se temperatura). (**Default**: 100.0)

267 5SPE. Soft-Start Percentage

Output percentage during soft-start function.

0..100%. (**Default**: 50%)

268 5SEH. Soft-Start Threshold

Threshold under which the soft-start percentage function is activated, at starting.

-9999...30000 [digit^{1 p.54}] (degrees.tenths for temp. sensors) (**Default**: 1000)

269 5SEt. Soft-Start Time

Max. Softstart duration: if the process will not reach the threshold selected on par. 5SEH. within the selected time, the controller starts to regulate on setpoint.

00:00 Disabled

00:01-24:00 hh:mm (**Default**: 00:15)

270 PARt. Maintenance Time

Maintenance time for pre-programmed cycle.

00:00-24:00

hh.mm (**Default**: 00:00)

271 FRGr. Falling Gradient

Falling gradient for pre-programmed cycle.

0 Disabled (**Default**)

1..10000 Digit/ora^{1 p.54} (degrees.tenths/hour if temperature)

272 dESE. Delayed Start

To set the initial waiting time for the delayed start of the setting or cycle, even in case of a blackout. The elapsed time is saved every 10 minutes.

0 Initial waiting time disabled: the controller starts immediately (**Default**)

00:01-24:00 hh.mm Initial waiting time enabled.

273÷276 Reserved Parameters - Group Q

Reserved parameters - Group Q

GROUP R - *dISP* - Display and interface

277 *uFLt* Visualization Filter

<i>dSRb.</i>	Disabled
<i>PtCHf</i>	Pitchfork filter (Default)
<i>F1.oRd.</i>	First Order
<i>F1.oP.P.</i>	First Order with Pitchfork
<i>2.SR.M.</i>	2 Samples Mean
.....	...n Samples Mean
<i>10.SR.M.</i>	10 Samples Mean

278 *uId2* Visualization Display 2

Selects visualization on display 2.

<i>c1.SP.V</i>	Command 1 setpoint (Default)
<i>ou.PE.1</i>	Percentage of command output 1
<i>AMPER.</i>	Ampere from current transformer

279 *tNo.d.* Timeout Display

Determines the display timeout

<i>dSRb.</i>	Disabled. Display always ON	5 M.N	5 minutes
	(Default)	10 M.N	10 minutes
15 S	15 seconds	30 M.N	30 minutes
1 M.N	1 minute	1 H	1 hour

280 *tNo.S.* Timeout Selection

Selects which display is switched off when Display Timeout expires

<i>dSP.1</i>	Display 1
<i>dSP.2</i>	Display 2 (Default)
<i>dSP.1.2</i>	Display 1 and 2
<i>d.1.2.Ld.</i>	Display 1, 2 and led

281 *uPr.c.* User Menu Pre-Programmed Cycle

Allows to modify rising/falling gradient and retention time from the user menu, in pre-programmed cycle functioning. To access parameter modification, press **SET**.

<i>dSRb.</i>	Disabled (Default)
<i>RiS.GR.</i>	Only rising gradient
<i>MR.t.</i>	Only retention time
<i>Ri.G.M.t.</i>	Rising gradient and retention time
<i>FRL.GR.</i>	Only falling gradient
<i>Ri.FR.G.</i>	Rising and falling gradient
<i>FR.G.M.t.</i>	Falling gradient and retention time
<i>Ri.F.G.M.t.</i>	Rising gradient, retention time and falling gradient

282 *uOut* Voltage Output

Selects the voltage on the sensors power terminals and of the digital outputs (SSR).

12 V	12 volt (Default)
24 V	24 volt

283 *ScL.t.* Scrolling Time

Select the duration for the visualization of the user menu data, before returning to the default page.

3 S	3 seconds	1 M.N	1 minutes
5 S	5 seconds (Default)	5 M.N	5 minutes
10 S	10 seconds	10 M.N	10 minutes
30 S	30 seconds	MRN.Sc.	Manual scroll

284 *dSPF.* Display Special Functions

d1SRb. Special functions disabled
5MRP Shows the setpoint on display 1 and the process on display 2 (only if Par. 278 *u.r.d.2* set on *c.ISPu*)

285 *nFcL.* **NFC Lock**

d1SRb. NFC lock disabled: NFC accessible.
ENRb. NFC lock enabled: NFC not accessible.

286 *5.F.5.F.* **Set Key Special Functions**

Assign special functions to the **SET** button. To execute the function the button must be pressed for 1 second.

d1SRb. No special function linked to the **SET** key. (Default)

5E.75E. Start/Stop. Pressing **SET** key the controller switches from Start to Stop and viceversa. Status of the controller, upon power-up, depends on parameter ini.s.

2E.5M. 2 Threshold Command Setpoint Switch. The controller changes the regulation setpoint alternating between Set1 and Set2

3E.5M. 3 Threshold Command Setpoint Switch. The controller changes the regulation setpoint alternating between Set1, Set2 and Set3

4E.5M. 4 Threshold Command Setpoint Switch. The controller changes the regulation setpoint alternating between Set1, Set2, Set3 and Set4

R.i. 0 Analogue Input 0. Set analogue input to zero (zero tare)

GROUP S - *cE* - Current Transformer

287 *cE.F.* **Current Transformer Function**

Enables the C.T. input and selects the net frequency

d1SRb. Disabilitato (Default)

50 HZ 50 Hz

60 HZ 60 Hz

288 *cE.u.* **Current Transformer Value**

Selects the amperometric transformer full-scale

1..200 Ampere (Default: 50)

289 *rES.* **Reserved**

Reserved parameter

290 *H.b.R.E.* **Heater Break Alarm Threshold**

Heater Break Alarm activation threshold

0 Alarm disabled. (Default:)

0.1-200.0 Ampere.

291 *oc.u.E.* **Overcurrent Alarm Threshold**

Overcurrent alarm threshold.

0 Alarm disabled. (Default)

0.1-200.0 Ampere

292 *H.b.R.d.* **Heater Break Alarm Delay**

Heater Break Alarm and overcurrent alarm activation delay.

00:00-60:00 mm:ss (Default: 01:00)

293÷297 **Reserved Parameters - Group S**

Reserved parameters - Group S

GROUP T - *R.O. 1* - Retransmission 1

298 *rEt1* Retransmission 1

Retransmission for AO1 output. Parameters 300 and 301 define lower and upper limit of the operating scale.

<i>dSRb.</i>	Disabled (Default)
<i>c.1.SPv</i>	Command 1 setpoint
<i>AL. 1</i>	Alarm 1 setpoint
<i>AL. 2</i>	Alarm 2 setpoint
<i>Md.bu5</i>	Retransmits the value written on word 1241
<i>R.N.1</i>	Value read on input AI1
<i>AMPER.</i>	Ampere from current transformer

299 *rEtY.* Retransmission 1 Type

Selects the retransmission type for AO1

<i>O.10 V</i>	Output 0...10 V.
<i>4.20mA</i>	Output 4...20 mA. Default

300 *r.l.LL.* Retransmission 1 Lower Limit

Retransmission 1 lower limit range (value related to 10 V or 0/4 mA).
-9999..+30000 [digit^{1 p.54}] (degrees if temperature), **Default**: 0.

301 *r.l.uL.* Retransmission 1 Upper Limit

Retransmission 1 upper limit range 2 (value related to 10 V or 20 mA).
-9999..+30000 [digit^{1 p.54}] (degrees if temperature), **Default**: 1000.

302 *r.lS.E.* Retransmission 1 State Error

Determines retransmission 1 value in case of error or anomaly

If the retransmission output is 0-10V:

<i>0 V</i>	0 V. Default
<i>10 V</i>	10 V.

If the retransmission output is 0-20 mA or 4-20 mA:

<i>0 mA</i>	0 mA. Default
<i>4 mA</i>	4 mA.
<i>20 mA</i>	20 mA.
<i>21.5mA</i>	21.5 mA.

303÷307 Reserved Parameters - Group T

Reserved parameters - Group T

GROUP U - *rES.* - Reserved

308÷317 Reserved Parameters - Group U

Reserved parameters - Group U

GROUP V - 5Er. - Serial

318 5LAd. Slave Address

Selects slave address for serial communication.
1...254. **Default:** 247.

319 bd.r.t. Baud Rate

Selects baudrate for serial communication

1.2 K	1200 bit/s
2.4 K	2400 bit/s
4.8 K	4800 bit/s
9.6 K	9600 bit/s
19.2 K	19200 bit/s (Default)
28.8 K	28800 bit/s
38.4 K	38400 bit/s
57.6 K	57600 bit/s
115.2K	115200 bit/s

320 5.P.P. Serial Port Parameters

Selects the format for the modbus RTU serial communication.

B-N-1	8 bit, no parity, 1 stop bit (Default)
B-E-1	8 bit, even parity, 1 stop bit
B-o-1	8 bit, odd parity, 1 stop bit
B-N-2	8 bit, no parity, 2 stop bit
B-E-2	8 bit, even parity, 2 stop bit
B-o-2	8 bit, odd parity, 2 stop bit

321 5E.dE. Serial Delay

Selects serial delay
0...100 ms. **Default:** 5 ms.

322 oFFL. Off Line

Selects the off-line time. If there is no serial communication during the selected time, the controller switches-off the command output.

0	Offline disabled (Default)
0.1-600.0	tenths of second.

323÷327 Reserved Parameters - Group V

Reserved parameters - Group V

GROUP W - *تایمر* - Timer

328 *تایمر 1* Timer 1

Enabling Timer 1

دیسآب. Disabled (**Default**)

فعال. Enabled

فعال و شروع. Enabled and active at start

329 *تایمر 1* Time Base Timer 1

Selects time base for timer 1

دقیقه.ثانیه minutes.seconds (**Default**)

ساعت.دقیقه hours.minutes

330 *تایمر 1* Action Timer 1

Select the type of the action executed by the timer 1 to be related to an alarm..

شروع Start. Active during timer counting (**Default**)

پایان End. Active at timer expiry

اخطار Warning. Active 5" before the timer expiry

331 *تایمر 2* Timer 2

Enabling Timer 2

دیسآب. Disabled (**Default**)

فعال. Enabled

فعال و شروع. Enabled and active at start

332 *تایمر 2* Time Base Timer 2

Selects time base for timer 2

دقیقه.ثانیه minutes.seconds (**Default**)

ساعت.دقیقه hours.minutes

333 *تایمر 2* Action Timer 2

Select the type of the action executed by the timer 2 to be related to an alarm.

شروع Start. Active during timer counting (**Default**)

پایان End. Active at timer expiry.

اخطار Warning. Active 5" before the timer expiry.

334 *تایمر 5* Timers Sequence

Select the correlation between the two timers.

تک. Singles. Timers work independently (**Default**)

توالی. Sequential. When timer 1 ends, timer 2 starts.

حلقه. Loop. When a timer ends, another starts.

335÷339 Reserved Parameters - Group W

Reserved parameters - Group W

12 Alarm Intervention Modes

12.a Absolute or threshold alarm active over (par. 123 $R.L.I.F. = Rb.u.PA$)

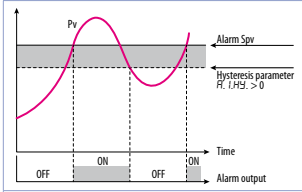

Absolute alarm active over.
Hysteresis value greater than "0" (Par. 128 $R.I.H.Y > 0$).

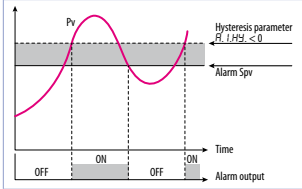

Absolute alarm active over.
Hysteresis value lower than "0" (Par. 128 $R.I.H.Y < 0$).

12.b Absolute or threshold alarm active below (par. 123 $R.L.I.F. = Rb.u.PA$)

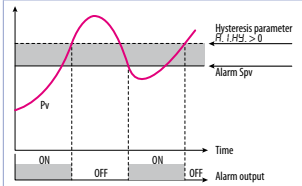

Absolute alarm active below.
Hysteresis value greater than "0" (Par. 128 $R.I.H.Y > 0$).

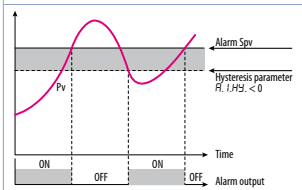

Absolute alarm active below.
Hysteresis value lower than "0" (Par. 128 $R.I.H.Y < 0$).

12.c Absolute or threshold alarm referred to command setpoint active over (par. 123 $R.L.I.F. = Rb.c.u.A$)

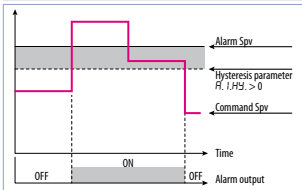

Absolute alarm referred to command setpoint active over. Hysteresis value greater than "0" (Par. 128 $R.I.H.Y > 0$).

12.d Absolute or threshold alarm referred to command setpoint active below (par. 123 $R.L.I.F. = Rb.c.l.A$)

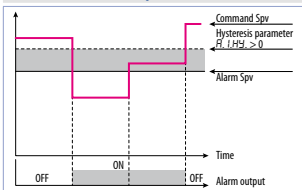

Absolute alarm referred to command setpoint active below.
Hysteresis value greater than "0" (Par. 128 $R.I.H.Y > 0$).

12.e Band alarm (par. 123 $R.L.I.F. = bRNd$)

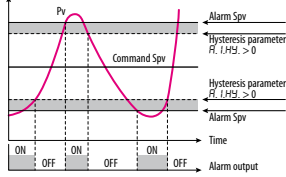

Band alarm hysteresis value greater than "0" (Par. 128 $R.L.H.Y. > 0$).

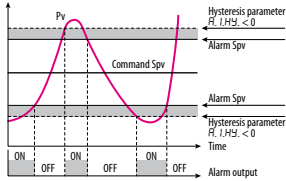

Band alarm hysteresis value lower than "0" (Par. 128 $R.L.H.Y. < 0$).

12.f Asymmetric band alarm (par. 123 $R.L.I.F. = R.bRNd$)

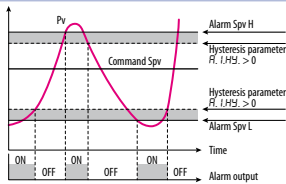

Asymmetric band alarm with hysteresis value greater than "0" (Par. 128 $R.L.H.Y. > 0$).

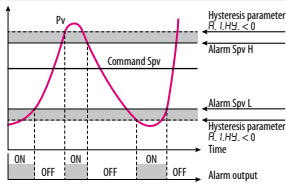

Asymmetric band alarm with hysteresis value lower than "0" (Par. 128 $R.L.H.Y. < 0$).

12.g Upper deviation alarm (par. 123 $R.L.I.F. = uP.dEu$)

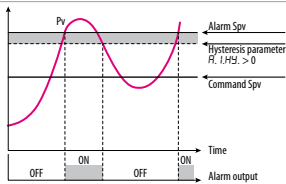

Upper deviation alarm value of alarm setpoint greater than "0" and hysteresis value greater than "0" (Par.128 $R.L.H.Y. > 0$).

NB: with hysteresis value less than "0" ($R.L.H.Y. < 0$) the dotted line moves under the alarm setpoint.

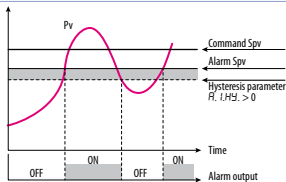

Upper deviation alarm value of alarm setpoint less than "0" and hysteresis value greater than "0" (Par.128 $R.L.H.Y. > 0$).

NB: with hysteresis value less than "0" ($R.L.H.Y. < 0$) the dotted line moves under the alarm setpoint.

12.h Lower deviation alarm (par. 123 $R.L.I.F. = Lo.dE_u$)

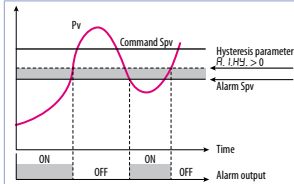

Lower deviation alarm value of alarm setpoint greater than "0" and hysteresis value greater than "0" (Par.128 $R.I.H.Y. > 0$).

NB: with hysteresis value less than "0" ($R.I.H.Y. < 0$) the dotted line moves under the alarm setpoint.

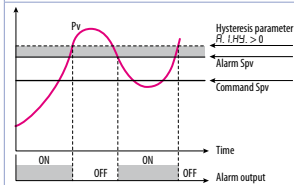

Lower deviation alarm value of alarm setpoint less than "0" and hysteresis value greater than "0" (Par.128 $R.I.H.Y. > 0$).

NB: with hysteresis value less than "0" ($R.I.H.Y. < 0$) the dotted line moves under the alarm setpoint.

12.1 Alarms label

By setting a value from 1 to 20 on the parameters 136 $R.1.Lb.$, 154 $R.2.Lb.$, 172 $R.3.Lb.$, 190 $R.4.Lb.$, 208 $R.5.Lb.$, the display 2 will show one of the following messages in case of alarm:

Selection	Message displayed in the alarm event
1	alarm 1
2	alarm 2
3	alarm 3
4	alarm 4
5	alarm 5
6	alarm 6
7	open door
8	closed door
9	light on
10	light off

Selection	Message displayed in the alarm event
11	warning
12	waiting
13	high limit
14	low limit
15	external alarm
16	temperature alarm
17	pressure alarm
18	fan command
19	cooling
20	operating

By setting 0, no message will be displayed. While setting 21, the user will have up to 23 characters available to customize his message via the "MyPyxsys" App or via modbus.

13 Fault reporting table

If installation malfunctions, the controller switches off the regulation output and reports the anomaly noticed. For example, controller will report failure of a connected thermocouple visualizing E-05 (flashing) flashing on display.

For other signals see table below.

	Cause	What to do
E-02 SYSTEM Error	Cold junction temperature sensor failure or environment temperature out of range	Call assistance
E-04 EEPROM Error	Incorrect configuration data. Possible loss of instrument calibration	Verify that configuration parameters are correct.
E-05 Probe 1 Error	Sensor connected to AI1 broken or temperature out of range	Control connection with probes and their integrity.
E-06 Probe 2 Error	Sensor connected to AI2 broken or temperature out of range	Control connection with probes and their integrity.
E-08 SYSTEM Error	Missing calibration	Call assistance
E-80 rFid Error	Tag rfid malfunctioning	Call assistance

Notes / Updates

- 1 Display of decimal point depends on setting of parameter $SEn.l$ and parameter $d.P.$ 2
- 2 On activation, the output is inhibited if the controller is in alarm mode. Activates only if alarm condition reappears, after that it was restored.
- 3 Changing the control setpoint, the alarm will be disabled. It will stay disabled as long as the parameters that created it are active. It only works with deviation alarms, band alarms and absolute alarms (referring to the control setpoint).

Table of configuration parameters

GROUP A - A.in.1 - Analogue input 1

1	<i>SEn.1</i>	Sensor AI1	26
2	<i>d.P. 1</i>	Decimal Point 1	26
3	<i>dEGr.</i>	Degree	26
4	<i>L.L. 1.1</i>	Lower Linear Input AI1	27
5	<i>u.L. 1.1</i>	Upper Linear Input AI1	27
6	<i>P.vA.1</i>	Potentiometer Value AI1	27
7	<i>i.o.L.1</i>	Linear Input over Limits AI1	27
8	<i>o.cA.1</i>	Offset Calibration AI1	27
9	<i>G.cA.1</i>	Gain Calibration AI1	27
10	<i>Ltc.1</i>	Latch-On AI1	27
11	<i>c.F.1</i>	Conversion Filter AI1	27
12	<i>c.Fr.1</i>	Conversion Frequency AI1	27
13	<i>L.c.E.1</i>	Lower Current Error 1	28
14÷17		Reserved Parameters - Group A	28

GROUP B - Res. - Reserved

18÷34		Reserved Parameters - Group B	28
-------	--	-------------------------------	----

GROUP C - cmd.1 - Outputs and regulation Process 1

35	<i>c.ov.1</i>	Command Output 1	28
36	<i>rES.</i>	Reserved	28
37	<i>rES.</i>	Reserved	28
38	<i>Ac.t.1</i>	Action type 1	28
39	<i>c.HY.1</i>	Command Hysteresis 1	28
40	<i>L.L.S.1</i>	Lower Limit Setpoint 1	29
41	<i>u.L.S.1</i>	Upper Limit Setpoint 1	29
42	<i>c.rE.1</i>	Command Reset 1	29
43	<i>c.S.E.1</i>	Command State Error 1	29
44	<i>c.Ld.1</i>	Command Led 1	29
45	<i>c.dE.1</i>	Command Delay 1	29
46	<i>c.S.P.1</i>	Command Setpoint Protection 1	29
47	<i>vA.t.1</i>	Valve Time 1	30
48	<i>A.MA.1</i>	Automatic / Manual 1	30
49	<i>in i.S.</i>	Initial State	30
50	<i>S.vAS.</i>	State Valve Saturation	30
51÷53		Reserved Parameters - Group C	30

GROUP D - res. - Reserved

54÷72		Reserved Parameters - Group D	30
-------	--	-------------------------------	----

GROUP E - reG.1 - Autotuning and PID 1

73	<i>tun.1</i>	Tune 1	30
74	<i>S.d.t.1</i>	Setpoint Deviation Tune 1	30
75	<i>P.b. 1</i>	Proportional Band 1	30
76	<i>i.t. 1</i>	Integral Time 1	30
77	<i>d.t. 1</i>	Derivative Time 1	31
78	<i>d.b. 1</i>	Dead Band 1	31
79	<i>P.b.c.1</i>	Proportional Band Centered 1	31
80	<i>o.o.S.1</i>	Off Over Setpoint 1	31
81	<i>o.d.t.1</i>	Off Deviation Threshold 1	31

82	<i>c.t. 1</i>	Cycle Time 1	31
83	<i>co.F.1</i>	Cooling Fluid 1	31
84	<i>P.b.1.1</i>	Proportional Band Multiplier 1	31
85	<i>o.d.b.1</i>	Overlap / Dead Band 1	31
86	<i>c.c.t.1</i>	Cooling Cycle Time 1	31
87	<i>LL.P.1</i>	Lower Limit Output Percentage 1	31
88	<i>u.L.P.1</i>	Upper Limit Output Percentage 1	32
89	<i>11.G.t.1</i>	Max Gap Tune 1	32
90	<i>11.n.P.1</i>	Minimum Proportional Band 1	32
91	<i>11.n.P.1</i>	Maximum Proportional Band 1	32
92	<i>11.n.i.1</i>	Minimum Integral Time 1	32
93	<i>o.c.L.1</i>	Overshoot Control Level 1	32
94÷97		Reserved Parameters - Group E	32

GROUP F - res. - Reserved

98÷122		Reserved Parameters - Group F	32
--------	--	-------------------------------	----

GROUP G - AL. 1 - ALARM 1

123	<i>AL.1.F.</i>	Alarm 1 Function	33
124	<i>rES.</i>	Reserved	33
125	<i>rES.</i>	Reserved	33
126	<i>AL.1.S.o.</i>	Alarm 1 State Output	33
127	<i>rES.</i>	Reserved	33
128	<i>AL.1.H.Y.</i>	Alarm 1 Hysteresis	33
129	<i>AL.1.L.L.</i>	Alarm 1 Lower Limit	33
130	<i>AL.1.u.L.</i>	Alarm 1 Upper Limit	34
131	<i>AL.1.rE.</i>	Alarm 1 Reset	34
132	<i>AL.1.S.E.</i>	Alarm 1 State Error	34
133	<i>AL.1.L.d.</i>	Alarm 1 Led	34
134	<i>AL.1.dE.</i>	Alarm 1 Delay	34
135	<i>AL.1.S.P.</i>	Alarm 1 Setpoint Protection	34
136	<i>AL.1.L.b.</i>	Alarm 1 Label	34
137÷140		Reserved Parameters - Group G	34

GROUP H - AL. 2 - ALARM 2

141	<i>AL.2.F.</i>	Alarm 2 Function	35
142	<i>rES.</i>	Reserved	35
143	<i>rES.</i>	Reserved	35
144	<i>AL.2.S.o.</i>	Alarm 2 State Output	35
145	<i>rES.</i>	Reserved	35
146	<i>AL.2.H.Y.</i>	Alarm 2 Hysteresis	35
147	<i>AL.2.L.L.</i>	Alarm 2 Lower Limit	35
148	<i>AL.2.u.L.</i>	Alarm 2 Upper Limit	36
149	<i>AL.2.rE.</i>	Alarm 2 Reset	36
150	<i>AL.2.S.E.</i>	Alarm 2 State Error	36
151	<i>AL.2.L.d.</i>	Alarm 2 Led	36
152	<i>AL.2.dE.</i>	Alarm 2 Delay	36
153	<i>AL.2.S.P.</i>	Alarm 2 Setpoint Protection	36
154	<i>AL.2.L.b.</i>	Alarm 2 Label	36
155÷158		Reserved Parameters - Group H	36

GROUP I - AL. 3 - ALARM 3

159	<i>AL.3.F.</i>	Alarm 3 Function	37
-----	----------------	------------------	----

160	<i>rES.</i>	Reserved	37
161	<i>rES.</i>	Reserved	37
162	<i>RS.o.</i>	Alarm 3 State Output	37
163	<i>RS.o.t.</i>	Alarm 3 Output Type	37
164	<i>RS.HY.</i>	Alarm 3 Hysteresis	37
165	<i>RS.LL</i>	Alarm 3 Lower Limit	38
166	<i>RS.u.L.</i>	Alarm 3 Upper Limit	38
167	<i>RS.rE.</i>	Alarm 3 Reset	38
168	<i>RS.S.E.</i>	Alarm 3 State Error	38
169	<i>RS.Ld.</i>	Alarm 3 Led	38
170	<i>RS.dE.</i>	Alarm 3 Delay	38
171	<i>RS.S.P.</i>	Alarm 3 Setpoint Protection	38
172	<i>RS.Lb.</i>	Alarm 3 Label	38
173÷176		Reserved Parameters - Group I	38

GROUP J - AL. 4 - ALARM 4

177	<i>AL.4.F.</i>	Alarm 4 Function	39
178	<i>rES.</i>	Reserved	39
179	<i>rES.</i>	Reserved	39
180	<i>RS.o.</i>	Alarm 4 State Output	39
181	<i>RS.o.t.</i>	Alarm 4 Output Type	39
182	<i>RS.HY.</i>	Alarm 4 Hysteresis	39
183	<i>RS.LL</i>	Alarm 4 Lower Limit	40
184	<i>RS.u.L.</i>	Alarm 4 Upper Limit	40
185	<i>RS.rE.</i>	Alarm 4 Reset	40
186	<i>RS.S.E.</i>	Alarm 4 State Error	40
187	<i>rES.</i>	Reserved	40
188	<i>RS.dE.</i>	Alarm 4 Delay	40
189	<i>RS.S.P.</i>	Alarm 4 Setpoint Protection	40
190	<i>RS.Lb.</i>	Alarm 4 Label	40
191÷194		Reserved Parameters - Group J	40

GROUP K - AL. 5 - Allarme 5 (solo su DRR244-13ABC e DRR244-23XX-T)

195	<i>RS.F.</i>	Alarm 5 Function	41
196	<i>rES.</i>	Reserved	41
197	<i>rES.</i>	Reserved	41
198	<i>RS.o.</i>	Alarm 5 State Output	41
199	<i>RS.o.t.</i>	Alarm 5 Output Type	41
200	<i>RS.HY.</i>	Alarm 5 Hysteresis	41
201	<i>RS.LL</i>	Alarm 5 Lower Limit	42
202	<i>RS.u.L.</i>	Alarm 5 Upper Limit	42
203	<i>RS.rE.</i>	Alarm 5 Reset	42
204	<i>RS.S.E.</i>	Alarm 5 State Error	42
205	<i>rES.</i>	Reserved	42
206	<i>RS.dE.</i>	Alarm 5 Delay	42
207	<i>RS.S.P.</i>	Alarm 5 Setpoint Protection	42
208	<i>RS.Lb.</i>	Alarm 5 Label	42
209÷212		Reserved Parameters - Group K	42

GROUP L - res - Reserved

213÷230		Reserved Parameters - Group L	43
---------	--	-------------------------------	----

GROUP M - d.i. 1 - Digital input 1

231	<i>d.i.1.F.</i>	Digital Input 1 Function	43
232	<i>d.i.1.c.</i>	Digital Input 1 Contact	43
233÷238		Reserved Parameters - Group M	43
GROUP N - d.i. 2 - Digital input 2			
239	<i>d.i.2.F.</i>	Digital Input 2 Function	44
240	<i>d.i.2.c.</i>	Digital Input 2 Contact	44
241÷246		Reserved Parameters - Group N	44
GROUP O - res. - Reserved			
247÷254		Reserved Parameters - Group O	44
GROUP P - res. - Reserved			
255÷262		Reserved Parameters - Group P	44
GROUP Q - sft.s - Soft-start and mini cycle			
263	<i>Pr.cY.</i>	Pre-programmed Cycle	45
264	<i>SS.tY.</i>	Soft-Start Type	45
265	<i>rES.</i>	Reserved	45
266	<i>SS.Gr.</i>	Soft-Start Gradient	45
267	<i>SS.PE.</i>	Soft-Start Percentage	45
268	<i>SS.tH.</i>	Soft-Start Threshold	45
269	<i>SS.t.i.</i>	Soft-Start Time	45
270	<i>MA.t.i.</i>	Maintenance Time	45
271	<i>FA.Gr.</i>	Falling Gradient	45
272	<i>dE.St.</i>	Delayed Start	45
273÷276		Reserved Parameters - Group Q	45
GROUP R - disp. - Display and interface			
277	<i>v.Flt</i>	Visualization Filter	46
278	<i>v.i.d.2</i>	Visualization Display 2	46
279	<i>tMo.d.</i>	Timeout Display	46
280	<i>tMo.S.</i>	Timeout Selection	46
281	<i>v.M.P.c.</i>	User Menu Pre-Programmed Cycle	46
282	<i>v.out</i>	Voltage Output	46
283	<i>ScL.t.</i>	Scrolling Time	46
284	<i>dSPF.</i>	Display Special Functions	46
285	<i>nFc.L.</i>	NFC Lock	47
286	<i>S.t.S.F.</i>	Set Key Special Functions	47
GROUP S - ct - Current Transformer			
287	<i>ct.F.</i>	Current Transformer Function	47
288	<i>ct.v.</i>	Current Transformer Value	47
289	<i>rES.</i>	Reserved	47
290	<i>H.b.R.t.</i>	Heater Break Alarm Threshold	47
291	<i>ocv.t.</i>	Overcurrent Alarm Threshold	47
292	<i>H.b.R.d.</i>	Heater Break Alarm Delay	47
293÷297		Reserved Parameters - Group S	47
GROUP T - a.o. 1 - Retransmission 1			
298	<i>rEt.1</i>	Retransmission 1	48
299	<i>r.t.tY.</i>	Retransmission 1 Type	48
300	<i>r.l.LL.</i>	Retransmission 1 Lower Limit	48
301	<i>r.l.uL.</i>	Retransmission 1 Upper Limit	48

302	<i>r.15.E.</i>	Retransmission 1 State Error	48
303÷307		Reserved Parameters - Group T	48
GROUP U - res. - Reserved			
308÷317		Reserved Parameters - Group U	48
GROUP V - ser. - Serial			
318	<i>SLAd.</i>	Slave Address	49
319	<i>bd.r.t.</i>	Baud Rate	49
320	<i>S.P.P.</i>	Serial Port Parameters	49
321	<i>SE.dE.</i>	Serial Delay	49
322	<i>oFFL.</i>	Off Line	49
323÷327		Reserved Parameters - Group V	49
GROUP W - timr - Timer			
328	<i>tNr.1</i>	Timer 1	50
329	<i>t.b.t.1</i>	Time Base Timer 1	50
330	<i>A.tNr.1</i>	Action Timer 1	50
331	<i>tNr.2</i>	Timer 2	50
332	<i>t.b.t.2</i>	Time Base Timer 2	50
333	<i>A.tNr.2</i>	Action Timer 2	50
334	<i>tNr.S.</i>	Timers Sequence	50
335÷339		Reserved Parameters - Group W	50

Read carefully the safety guidelines and programming instructions contained in this manual before using/connecting the device.

Prima di utilizzare il dispositivo leggere con attenzione le informazioni di sicurezza e settaggio contenute in questo manuale.

Avant d'utiliser le dispositif lire avec attention les renseignements de sûreté et installation contenus dans ce manuel.



RoHS 
Compliant



PIXSYS s.r.l.

www.pixsys.net

sales@pixsys.net - support@pixsys.net

online assistance: <http://forum.pixsys.net>

via Po, 16 I-30030

Mellaredo di Pianiga, VENEZIA (IT)

Tel +39 041 5190518



2300.10.304-RevA

Rev. firmware 2.07

030620