



ATR144

Controller



User manual

Table of contents

1	Safety guidelines.....	6
1.1	Organization of safety notices	7
1.2	Safety Precautions.....	7
1.3	Precautions for safe use	8
1.4	Environmental policy / WEEE	9
2	Model identification.....	10
3	Technical data	10
3.1	General features	10
3.2	Hardware features	11
3.3	Software features.....	12
3.4	Programming mode	12
4	Dimensions and installation.....	13
5	Electrical wirings.....	13
5.1	Wiring diagram	14
6	Display and key functions.....	19
6.1	Numeric indicators (display).....	19
6.2	Meaning of status lights (Led)	20
6.3	Keys.....	20
7	Controller Functions	21
7.1	Modification of main and alarm setpoint value	21
7.2	Automatic Tune.....	21
7.3	Manual Tune.....	22
7.4	Tuning performed once	22
7.5	Synchronized Tuning.....	23
7.6	Digital input functions.....	24
7.7	Automatic / Manual regulation for % output control.....	26
7.8	Loop Break.....	27
7.9	Dual Action (Heating-Cooling).....	28
7.10	Funzione LATCH ON.....	30
7.11	Soft start function.....	31
7.12	Pre-programmed cycle.....	32
8	Serial communication	33
8.1	Slave.....	33
8.2	Master	40
9	Reading and configuration through NFC	44
10	Access configuration.....	46
10.1	Loading default values	47

10.2 Parameters list functioning	47
11 Table of Configuration Parameters	48
12 Alarm Intervention Modes.....	81
12.1 Alarms label.....	85
13 Table of anomaly signals	85

Blank Page

Introduction

PID Controller ATR144 relies on Pixsys flagship programming mode by NFC/RFID technology with dedicated App MyPixsys for Android devices not requiring wirings and power supply, allowing quick set-up/updates on site.

The outputs can be selected as command/multiple alarm modes. Serial communication standard is RS485 (isolated) with Modbus RTU Master/Slave protocol. Power supply with extended range 24 to 230V AC/DC with galvanic insulation from the network.

1 Safety guidelines

Read carefully the safety guidelines and programming instructions contained in this manual before connecting/using the device.

Disconnect power supply before proceeding to hardware settings or electrical wirings to avoid risk of electric shock, fire, malfunction.

Do not install/operate the device in environments with flammable/explosive gases.

This device has been designed and conceived for industrial environments and applications that rely on proper safety conditions in accordance with national and international regulations on labour and personal safety. Any application that might lead to serious physical damage/ life risk or involve medical life support devices should be avoided.

Device is not conceived for applications related to nuclear power plants, weapon systems, flight control, mass transportation systems.

Only qualified personnel should be allowed to use device and/or service it and only in accordance to technical data listed in this manual.

Do not dismantle/modify/repair any internal component.

Device must be installed and can operate only within the allowed environmental conditions. Overheating may lead to risk of fire and can shorten the lifecycle of electronic components.

1.1 Organization of safety notices

Safety notices in this manual are organized as follows:

Safety notice	Description
Danger!	Disregarding these safety guidelines and notices can be life-threatening.
Warning!	Disregarding these safety guidelines and notices can result in severe injury or substantial damage to property.
Information!	This information is important for preventing errors.

1.2 Safety Precautions

Danger!	CAUTION - Risk of Fire and Electric Shock. This product is UL listed as open type process control equipment. It must be mounted in an enclosure that does not allow fire to escape externally.
Danger!	If the output relays are used past their life expectancy, contact fusing or burning may occasionally occur. Always consider the application conditions and use the output relays within their rated load and electrical life expectancy. The life expectancy of output relays varies considerably with the output load and switching conditions.
Warning!	Loose screws may occasionally result in fire. For screw terminals tighten screws to tightening torque of 0,5 Nm.

Warning!

A malfunction in the Digital Controller may occasionally make control operations impossible or prevent alarm outputs, resulting in property damage. To maintain safety in the event of malfunction of the Digital Controller, take appropriate safety measures, such as installing a monitoring device on a separate line.

1.3 Precautions for safe use

Be sure to observe the following precautions to prevent operation failure, malfunction, or adverse affects on the performance and functions of the product. Not doing so may occasionally result in unexpected events. Do not handle the Digital Controller in ways that exceed the ratings.

- The product is designed for indoor use only. Do not use or store the product outdoors or in any of the following places.
 - Places directly subject to heat radiated from heating equipment.
 - Places subject to splashing liquid or oil atmosphere.
 - Places subject to direct sunlight.
 - Places subject to dust or corrosive gas (in particular, sulfide gas and ammonia gas).
 - Places subject to intense temperature change.
 - Places subject to icing and condensation.
 - Places subject to vibration and large shocks.
- Installing two or more controllers in close proximity might lead to increased internal temperature and this might shorten the life cycle of electronic components. It is strongly recommended to install cooling fans or other air-conditioning devices inside the control cabinet.
- Always check the terminal names and polarity and be sure to wire properly. Do not wire the terminals that are not used.
- To avoid inductive noise, keep the controller wiring away from power cables that carry high voltages or large currents. Also, do not wire power lines together

with or parallel to Digital Controller wiring. Using shielded cables and using separate conduits or ducts is recommended. Attach a surge suppressor or noise filter to peripheral devices that generate noise (in particular motors, transformers, solenoids, magnetic coils or other equipment that have an inductance component). When a noise filter is used at the power supply, first check the voltage or current, and attach the noise filter as close as possible to the Digital Controller. Allow as much space as possible between the Digital Controller and devices that generate powerful high frequencies (high-frequency welders, high-frequency sewing machines, etc.) or surge.

- A switch or circuit breaker must be provided close to device. The switch or circuit breaker must be within easy reach of the operator, and must be marked as a disconnecting means for the controller.
- The device must be protected by a fuse 1A (cl. 9.6.2).
- Wipe off any dirt from the Digital Controller with a soft dry cloth. Never use thinners, benzine, alcohol, or any cleaners that contain these or other organic solvents. Deformation or discoloration may occur.
- The number of non-volatile memory write operations is limited. Therefore, use EEprom write mode when frequently overwriting data, e.g.: through communications.

1.4 Environmental policy / WEEE

Do not dispose electric tools together with household waste material.

According to European Directive 2012/19/EU on waste electrical and electronic equipment and its implementation in accordance with national law, electric tools that have reached the end of their life must be collected separately and returned to an environmentally compatible recycling facility.

2 Model identification

The ATR144 series includes 2 versions:

Power supply 24..230 VAC/VDC $\pm 15\%$ 50/60 Hz – 5 Watt/VA	
ATR144-ABC	1 analogue input + 2 relays 5 A + 1 D.I/O
ATR144-ABC-T	1 analogue input + 1 relays 5 A + 1 D.I/O + RS485

3 Technical data

3.1 General features

Displays	4 digits 9.6 mm (0.38 pollici), 5 digits 7.1 mm (0.28 pollici)
Operative conditions	Temperature: 0-45° C -Humidity 35..95 uR% Max. altitude: 2000m
Sealing	IP65 front panel (with gasket) IP20 box and terminals
Materials	Box and front panel: PC UL94V2 self-extinguishing
Weight	Approx. 120 g

3.2 Hardware features

Analogue input	<p>AI1: Configurable via software. Input: Thermocouple type K, S, R, J,T,E,N,B. Automatic compensation of cold junction from -25...85° C. Thermoresistances: PT100, PT500, PT1000, Ni100, Ni120, PTC 1K, NTC 10K (β 3435K and β3694K), NTC 2252 (β3976K) Input V/mA: 0-1 V, 0-5 V, 0-10 V, 0-20 o 4-20 mA, 0-60 mV. Pot. Input: 1...150 KΩ.</p>	<p>Tolerance (25° C) $\pm 0.2\% \pm 1$ digit (on F.s.) for thermocouple, thermoresistance and V/mA. Cold junction accuracy 0.1° C/°C.</p> <p>Impedence: 0-10 V: Ri>110 KΩ 0-20 mA: Ri<5 Ω 0-40 mV: Ri>1 MΩ</p>
Relay outputs	Configurable as command and alarm output.	Contacts: 5 A - 250 VAC Resistive load.
SSR outputs	Configurable as command and alarm output.	12 V, 25 mA. Min. load 1 mA
Power-supply	Extended power-supply 24..230 VAC/VDC $\pm 15\%$ 50/60 Hz Overvoltage category: II	Consumption: 5 Watt/VA

3.3 Software features

Regulation algorithms	ON-OFF with hysteresis. P, PI, PID, PD with proportional time
Proportional band	0..9999°C o °F
Integral time	0,0..999,9 sec (0 exclude)
Derivative time	0,0..999,9 sec (0 exclude)
Controller functions	Manual or automatic Tuning, selectable alarm, protection of command and alarm setpoints.

3.4 Programming mode

by keyboard	..see paragraph 10
software LabSoftview	..on "Download section" of official pixsys site: www.pixsys.net
App MyPixsys	..through download the App on Google Play Store®, see paragraph 9 When activated by a reader/interrogator supporting NFC-V protocol, controller ATR244 is to be considered a VICC (Vicinity Inductively Coupled Card) according to ISO/IEC 15693 and it operates at a frequency of 13.56 MHz. The device does not intentionally emit radio waves.

4 Dimensions and installation

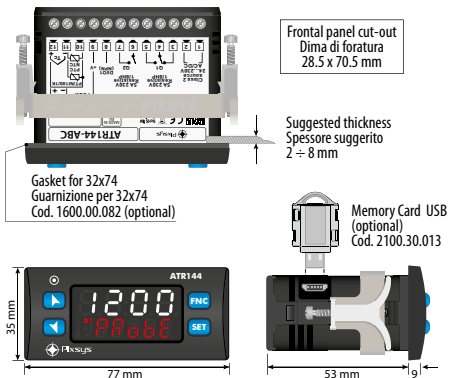

5 Electrical wirings

This controller has been designed and manufactured in conformity to Low Voltage Directive 2006/95/EC, 2014/35/EU (LVD) and EMC Directive 2004/108/EC, 2014/30/EU (EMC). For installation in industrial environments please observe following safety guidelines:

- Separate control line from power wires.
- Avoid proximity of remote control switches, electromagnetic contactors, powerful engines.
- Avoid proximity of power groups, especially those with phase control.
- It is strongly recommended to install adequate mains filter on power supply of the machine where the controller is installed, particularly if supplied 230 VAC.

The controller is designed and conceived to be incorporated into other machines, therefore CE marking on the controller does not exempt the manufacturer of machines from safety and conformity requirements applying to the machine itself.

- Wiring ATR244, use crimped tube terminals or flexible/rigid copper wire with diameter 0.14 to 2.5 mm² (min. AWG26, max. AWG14). Cable stripping length is 7 mm.
- It is possible to connect on a single terminal two wires with same diameter comprised between 0.14 and 0.75mm².

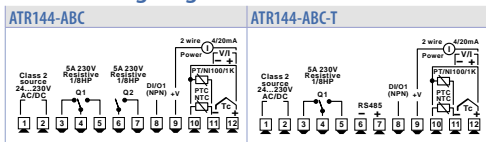

5.1 Wiring diagram

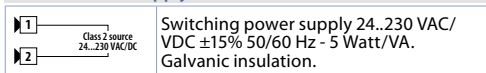

5.1.a Power supply

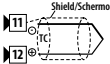
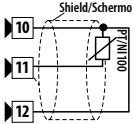

5.1.b Analogue input AI1

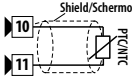
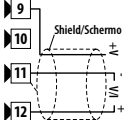
	<p>For thermocouples K, S, R, J, T, E, N, B.</p> <ul style="list-style-type: none">• Comply with polarity• For possible extensions, use compensated cable and terminals suitable for the thermocouples used (compensated).• When shielded cable is used, it should be grounded at one side only.
 	<p>For thermoresistances PT100, Ni100.</p> <ul style="list-style-type: none">• For the three-wire connection use wires with the same section.• For the two-wire connection short-circuit terminals 10 and 12.• When shielded cable is used, it should be grounded at one side only.
	<p>For thermoresistances NTC, PTC, PT500, PT1000 and linear potentiometers.</p> <ul style="list-style-type: none">• When shielded cable is used, it should be grounded at one side only to avoid ground loop currents.
	<p>For linear signals in Volt and mA</p> <ul style="list-style-type: none">• Comply with polarity• When shielded cable is used, it should be grounded at one side only to avoid ground loop currents.

5.1.c Examples of connection for linear input

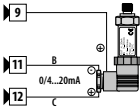
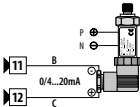
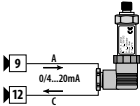
	<p>For signals 0..10V</p> <ul style="list-style-type: none">• Comply with polarity
	<p>For signals 0/4..20mA with three-wire sensor</p> <ul style="list-style-type: none">• Comply with polarity <p>C = Sensor output B = Sensor ground A = Sensor power supply (12V/30mA)</p> <p>In the picture: pressure sensor.</p>
	<p>For signals 0/4..20mA with external power of sensor</p> <ul style="list-style-type: none">• Comply with polarity <p>C = Sensor output B = Sensor ground</p> <p>In the picture: pressure sensor. Connect the external power supply to pins P and N.</p>
	<p>For signals 0/4..20mA with two-wire sensor</p> <ul style="list-style-type: none">• Comply with polarity <p>C = Sensor output A = Sensor power supply (12V/30mA)</p> <p>In the picture: pressure sensor.</p>

5.1.d Digital input 1



Digital input can be enabled by parameter.

Close pin 8 "DI/O1" on pin 9 "+V" to enable digital input.

5.1.e Digital input 2



Digital input can be enabled by parameter. Not available when a resistive sensor (thermoresistances or potentiometers) is selected.

Close pin 10 on pin 11 to enable digital input.

5.1.f Serial input (only on ATR144-ABC-T)

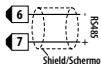

Modbus RS485 communication.
RTU Slave with galvanic insulation.

It is recommended to use the twisted and shielded cable for communications.

5.1.g Digital output



Digital output NPN (including SSR) for command or alarm.
Range 12 VDC/25 mA.

5.1.h Relay output Q1

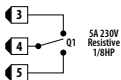

Capacity 5 A / 250 VAC for resistive loads.
See chart below.

5.1.i Relay output Q2 (only on ATR144-ABC)

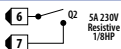

Capacity 5 A / 250 VAC for resistive loads.
See chart below.

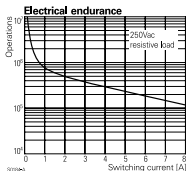

Contact Q1 e Q2:

- **Rating (resistive):** 250 VAC/30 VDC, 5A
- **Maximum switching power:** 1250 VA/150W

Life:

- **Mechanical:** min. 5×10^6 operations
- **Electrical:** min. 100×10^3 operations

6 Display and key functions







6.1 Numeric indicators (display)

1	1234	Normally displays the process. During the configuration phase, it displays the parameter groups or the parameter being inserted.
2	ProbE	Normally displays the setpoint. During the configuration phase, it displays the parameter value being inserted.

6.2 Meaning of status lights (Led)

3	C	ON when the command output 1 is active. In case of motorized valve control it is ON during valve opening and flashes during valve closing.
4	A1	ON when alarm 1 is active.
5	A2	ON when alarm 2 is active.
6	T	ON when the controller is executing an auto-tuning cycle.
7	M	ON when "Manual" function is active.
8	R	ON when the controller communicates through serial. Flashes when the remote setpoint is enabled.



6.3 Keys

9		<ul style="list-style-type: none">• Increases the main setpoint.• During configuration allows to scroll the parameters or the groups of parameters.• Increases the setpoints.
10		<ul style="list-style-type: none">• Decreases the main setpoint.• During configuration allows to scroll the parameters or the groups of parameters.• Decreases the setpoints.
11		<ul style="list-style-type: none">• Allows to visualize command and alarm setpoints.• During configuration allows to enter the parameter to be modified and confirms the variation.
12		<ul style="list-style-type: none">• Allows to enter the Tuning launch function, automatic/manual selection.• During configuration works as exit key (ESCAPE).

7 Controller Functions

7.1 Modification of main and alarm setpoint value

Setpoint value can be modified from keyboard as follows:

	Press	Display	Do
1		Value on display 2 changes.	Increases or decreases the main setpoint value.
2	SET	Visualizes the other setpoints on display 1. Display 2 shows the setpoint type.	
3		Value on display 1 changes.	Increases or decreases the alarm setpoint value.

7.2 Automatic Tune

Automatic tuning procedure allows a precise regulation without detailed knowledge of PID regulation algorithm. Selecting Auto on par. 36 *turn.l*, the controller analyzes the proces oscillations and optimizes the PID parameters.

Led T flashes.

If the PID parameters are not yet selected, at the device switch-on, the manual tunig procedure described in the next paragraph will be launched described into the next paragraph.

7.3 Manual Tune

Manual procedure allows the user greater flexibility to decide when to update

PID algorithm parameters. During the manual tuning, the device generates a step to analyze the system inertia to be regulated and, according to the collected data, modifies PID parameters.

After selecting **MANU.** on par. 33 **tun.1**, the procedure can be activated in three ways:

- **Running Tuning by keyboard:**

Press **FNC** until display 2 shows **tunE** with display 1 on **d.15.** and then press **SET**: display 1 shows **EnAb.** Led T switches ON and the procedure starts.

- **Running Tuning by digital input:**

Select **tunE** on par. 94 **d.1.F.** or on par. 101 **d.1.2F.**. At first activation of digital input (commutation on front panel) led T led switches on and at second activation switches off.

- **Running Tuning by serial input:**

Write 1 on word modbus 1210: led T switches ON and the procedure starts. Write 0 to stop the tuning.

To avoid an overshoot, the threshold where the controller calculates new PID parameters is determined by this operation:

Tune threshold = Setpoint - "Set Deviation Tune" (par. 37 **S.d.t.1**)

Ex.: if the setpoint is 100.0 °C and the Par. 37 **S.d.t.1** is 20.0 °C the threshold to calculate PID parameters is $(100.0 - 20.0) = 80.0^{\circ}\text{C}$.

For a greater precision on PID parameters calculation it is suggested to start the manual tuning procedure when the process is not close to setpoint value.

7.4 Tuning performed once

Set **onceE** on parameter 36 **tun.1**, or on parameter 98 **tun.2**.

Autotuning procedure is executed only once at next ATR144 restart. If the procedure doesn't work, it will be executed at next restart.

7.5 Synchronized Tuning

Set *Synch.* on parameter 36 *tun.l.*

This procedure has been conceived to calculate correct PID values on multi-zone systems, where each temperature is influenced by the adjacent zones.

Writing on word modbus 1210 the controller works as follows:

Word value	Action
0	Tune off
1	Command output OFF
2	Command output ON
3	Tune active
4	Tune completed: command output OFF (read only)
5	Tune not available: softstart function enabled (only reading)

Here below the functioning for regulation loop: the master switches-off or turns-on all zones (value 1 or 2 on word 1210) for a time long enough to create inertia on the system.

At this point the autotuning is launched (value 3 on word 1210). The controller executes the procedure for the calculation of the new PID values. When the procedure ends, the controller switches off the command output and selects the value 4 on word 1210. The Master, always reading word 1210, will control the various zones and when all will have finished, it will set to 0 the value of word 1210: the various devices will regulate the temperature independently, with the new calculated values. N.B. The master must read the word 1210 at least every 10 seconds or the controller will automatically exit the autotuning procedure.

7.6 Digital input functions

The ATR144 functions related to digital inputs can be enabled by parameters 94 *d. i. 1F.* and 101 *d. i. 2F.*

- *2t5U.*: Two threshold setpoint modification: with digital input active the ATR144 regulates on **SET2**, otherwise it regulates on **SET1**;
- *2t5U. i.*: Modification of 2 setpoints by digital input with impulse command;
- *3t5U. i.*: Modification of 3 setpoints by digital input with impulse command,
- *4t5U. i.*: Modification of 4 setpoints by digital input with impulse command,
- *5t.r5t.*: Start / Stop of the controller by digital input with impulse command. Status of the controller, upon power-up, depends on parameter 30 *in i. 5* ;
- *run.*: The regulation is enabled only with digital input active. With the controller in STOP the alarms remain active.
- *EHtAL.*: when the digital input is active, the controller goes on STOP and the alarms will be disabled. The controller does not return to START automatically: for this operation, the user's intervention is required (turning the ATR144 off and on again, or activating the digital input set to *5t.r5t.*, or pressing the **SET** button if the parameter 130 *5t.5F.* is set to *5t.r5t.*, or start from serial port).
- *Hold.*: With digital input active the conversion is locked (visualization maintenance function);
- *tunE.*: Enables/disables the Tuning if par. 36 *tun.l* is set on *PARU.*;
- *Au.PA. i.*: If par. 29 *A.PA.l* is selected as *EnAb.* or *En.5t.*, with impulse command on digital input, the ATR144 switches the related regulation loop, from automatic to manual and vice versa.
- *Au.PA.c.*: If par. 29 *A.PA.l* is selected as *EnAb.* or *En.5t.*, the ATR144 switches to manual the related regulation loop, with digital input active, otherwise the regulation is automatic.
- *Act.tY.*: The ATR144 execute a cooling type regulation with

digital input active, otherwise the regulation is of heating type;

- *R.i.0*: Zero tare function: brings the related analogue input to 0.
- *PrES*: Allows the reset of the command and alarm outputs if manual reset is active.
- *t1.run*: If timer 1 is enabled (par. 186 *tPr.1* different from *dISA*), with digital input active, the timer is switched to RUN, otherwise is kept in STOP;
- *t1.S.E*: If timer 1 is enabled (par. 186 *tPr.1* different from *dISA*), acting on the digital input, the status of the timer switches from STOP to RUN e vice versa;
- *t1.S.tA*: If il timer 1 is enabled (par. 186 *tPr.1* different from *dISA*), acting on the digital input, the timer is switched to RUN;
- *t1.End*: If il timer 1 is enabled (par. 186 *tPr.1* different from *dISA*), acting on the digital input, the timer is switched to STOP;

- *t2.run*: If timer 2 is enabled (par. 189 *tPr.2* different from *dISA*), with digital input active, the timer is switched to RUN, otherwise is kept in STOP;
- *t2.S.E*: If timer 2 is enabled (par. 189 *tPr.2* different from *dISA*), acting on the digital input, the status of the timer switches from STOP to RUN e vice versa;
- *t2.S.tA*: If timer 2 is enabled (par. 189 *tPr.2* different from *dISA*), acting on the digital input, the timer is switched to RUN;
- *t2.End*: If timer 2 is enabled (par. 189 *tPr.2* different from *dISA*), acting on the digital input, the timer is switched to STOP;
- *Lo.cFG*: With digital input active, the access to setpoint configuration/modification is locked;
- *uP.tEY*: simulates the operation of the up button.
- *doUn.t*: simulates the operation of the down button.
- *Fnc .t*: simulates the operation of the **FNC** button.
- *SEt .t*: simulates the operation of the **SET** button.

7.7 Automatic / Manual regulation for % output control

This function allows to switch from automatic functioning to manual command of the output percentage. The cycle time is set in parameter 45 c.t. 1 ("Cycle Time 1").

With par. 29 *Α.Π.Α.Ι* it is possible to select two modes.

1 **First selection** (*ΕπΑβ.*) allows to enable with **FNC** the writing *P:---* on display 1, while on display 2 is showed *Αυτοπ.*

Press **SET** to visualize *ΠΑΝΟ*; it's now possible, during the process visualization, modify through the keys **▲** and **▼** the output percentage. To back to automatic, with the same procedure, select *Αυτοπ.* on display 2: immediately led M switches off and functioning backs to automatic.

2 **Second selection** (*Επ.5εα.*) enables the same functioning but with two important variants:

- If there is a temporary power failure or after switch-off, the manual functioning as well as the previous output percentage value will be maintained at restarting.
- If the sensor breaks during automatic functioning, the controller switches to manual mode while maintaining the output percentage command unchanged as generated by the PID immediately before breakage.

Ex: on an extruder the command in percentage of the resistance (load) is maintained also in case of input sensor failure.

7.8 Loop Break

The function Loop Break allows to detect a failure on the control loop. During activation of the actuator, the process is supposed to change towards the setpoint. If this change is not consistent or fast enough, atr144 will display the message "loop break alarm". This message won't be shown if parameter 62 or 78 are set to "L.B.A" - in this case the regulator generates an alarm, enables the corresponding output and displays the message selected in the parameter 72 ("alarm 1 label") or 88 (alarm 2 label).

This is only a software control and it only occurs in the output saturation phase (control percentage 0% or 100%); it should not be mistaken with a partial or total failure of the load, which is measured, for example, using a current transformer. Setting manu. in the parameter 141 L.b.S. ("Loop Break State"), the controller checks if the process has changed at least by the value set in the parameter 143 L.b.b. ("Loop Break Band"), in a maximum time equal to the value of the parameter 142 L.b.t. ("Loop Break Time").

If you set autom. in the parameter 141 L.b.S. ("Loop Break State"), the values concerning time and change of control are calculated automatically, but only if the setting action is made by PID, PI or PD.

The band will assume a value of $0.5 \cdot P_b$, and the time will be $2 \cdot T_i$ in case of PID or PI setting, or $12 \cdot T_d$ in case of PD setting.

7.9 Dual Action (Heating-Cooling)

ATR144 is suitable also for systems requiring a combined heating-cooling action.

The command output has to be configured as PID for Heating (Par. 19 $P.c.t.l = HEAT$ and $P.b. 1$ greater than 0), and one of the alarms ($AL.1.F.$ or $AL.5.F.$) has to be configured as $COOL$.

The command output must be connected to the actuator responsible for heating, while the alarm will control cooling action.

Parameters to be configured for the heating PID are:

$P.c.t.l = HEAT$ Command output action type (Heating);

$P.b. 1$ or $P.b. 2$: Heating proportional band;

$i.t. 1$ or $i.t. 2$: Integral time of heating and cooling;

$d.t. 1$ or $d.t. 2$: Derivative time of heating and cooling;

$c.t. 1$ or $c.t. 2$: Heating time cycle.

Parameters to be configured for the cooling PID related to regulation loop 1 and alarm 1 are:

$AL.1.F. = COOL$. Alarm 1 selection (Cooling);

$P.b.\Pi.1$: Proportional band multiplier;

$\sigma.d.b.1$: Overlapping / Dead band;

$c.c.t.1$: Cooling time cycle.

Par. $P.b.\Pi.1$ (that ranges from 1.00 to 5.00) determines the proportional band of cooling action basing on the formula:

Proportional band for cooling action = $P.b. 1 \times P.b.\Pi.1$

This gives a proportional band for cooling which will be the same as heating band if $P.b.\Pi.1 = 1.00$, or 5 times greater if $P.b.\Pi.1 = 5.00$.

Integral and derivative time are the same for both actions.

Par. $\sigma.d.b.1$ determines the percentage overlapping between the two actions. For systems in which the heating output and cooling output must never be simultaneously active a Dead Band ($\sigma.d.b.1 \leq 0$), must be configured, vice versa you can configure an overlapping ($\sigma.d.b.1 > 0$).

The following figure shows an example of dual action PID (heating-cooling) with $i.t. 1 = 0$ e $d.t. 1 = 0$.

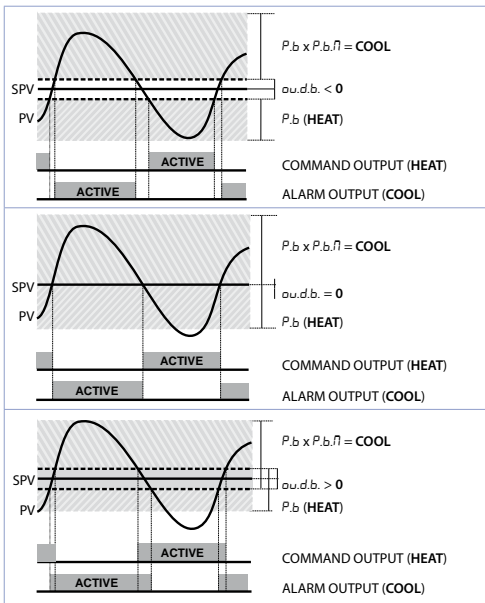

Parameter $c.c.t.l$ has the same meaning of cycle time for heating action $c.t.l$.

Parameter $co.F.l$ (Cooling Fluid) pre-selects the proportional band multiplier $P.b.\eta.l$ and the cooling PID cycle time $c.c.t.l$ according to cooling fluid type:

<i>co.F.l</i>	Cooling fluid type	<i>P.b.Π.l</i>	<i>c.c.t.l</i>
<i>Air</i>	Air	1.00	10
<i>oil</i>	Oil	1.25	4
<i>H₂O</i>	Water	2.50	2



Once parameter *co.F.l* has been selected, the parameters *P.b.Π.l*, *o.d.b.l* and *c.c.t.l* can be however modified.

7.10 Funzione LATCH ON

For use with input *P_{o.t.}* and with linear input (0..10 V, 0..40 mV, 0/4..20 mA) it is possible to associate start value of the scale (par. 4 *LL.i.l*) to the minimum position of the sensor and value of the scale end (par. 5 *u.L.i.l*) to the maximum position of the sensor (par. 10 *Lt.c.l* configured as *StnDr*).

It is also possible to fix the point in which the controller will display 0 (however keeping the scale range between *LL.i.l* and *u.L.i.l*) using the "virtual zero" option by selecting *u.D.Sto.* or *u.D.Stn.* on par. 10 *Lt.c.l*. Selecting *u.D.Stn.* the virtual zero must be reset at each restart; selecting *u.D.Sto.* the virtual zero will remain fixed once calibrated. To use the LATCH ON function, configure the par. *Lt.c.l*.

Then refer to the following table for the calibration procedure:

	Press	Display	Do
1		Exit parameters configuration. Display 2 visualizes writing <i>LAt.c.</i>	Place the sensor on minimum operating value (corresponding to <i>LL.i.l</i>)
2		Store value on minimum. Display shows <i>LoU</i> .	Place sensor on maximum operating value (corresponding to <i>u.L.i.l</i>).
3		Store value on max. Display shows <i>HiU</i> .	To exit standard proceeding press SET . For "virtual zero" setting, place the sensor to zero point.

	Press	Display	Do
4	FNC	Set virtual zero. Display shows ΔERD . If "Virtual zero at start" is selected, point 4 must be repeated at each starting.	To exit procedure press SET .



7.11 Soft start function

ATR144 is provided with two types of softstart selectable on parameter 110 $SS.tY$. ("Softstart Type").

- 1 First selection ($GRAd$) enables gradient softstart. At starting the controller reaches setpoint basing on the rising gradient set on parameter 111 $SS.Gr$. ("Softstart Gradient") in Unit/hour (ex. °C/h). If parameter 114 $SS.ti$. ("Softstart Time") is different to 0, at starting when the time selected on par. 114 $SS.ti$. is elapsed, the controller stops to follow the gradient and reaches setpoint with the maximum power.
- 2 Second selection ($PERC$) enables output percentual softstart. On par. 113 $SS.tH$. it is possible to set the threshold under which starts the softstart ("Softstart Threshold"). On par. 112 $SS.PE$. ("Softstart Percentage") an output percentage is selectable (from 0 to 100), which controller keeps until the process exceeds the threshold set on par. 113 $SS.tH$. or until the time in minutes set on par. 114 $SS.ti$. ("Softstart Time").

If the Sof-Start function is active the automatic/manual Tuning function cannot be activated.

7.12 Pre-programmed cycle

Pre-programmed cycle function activates by setting $ENAB.$ on parameter 109 $Pr.c4.$

Controller reaches setpoint 1 basing on the gradient set on parameter 111 $SS.Gr.$, then it reaches max. power up to setpoint 2. When the process reaches max. power, this setpoint is maintained for the time set on parameter 115 $MA.t.$..

At expiry, process will reach ambient temperature according to gradient entered on parameter 116 $FA.Gr.$, then command output will be disabled and display will visualize $Stop$.

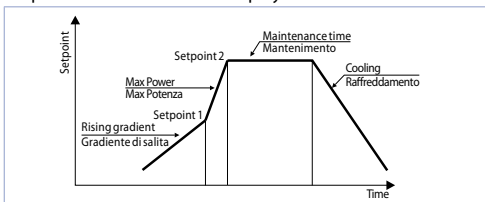

Cycle starts at each activation of the controller, or via digital input if it is enabled for this type of functioning (parameters 94 $d. i.F.$, or 101 $d. i.ZF.$ set as Set , Set or Run).

8 Serial communication

8.1 Slave

ATR144-xxxxx-T is equipped with RS485 and can receive/broadcast data via serial communication using MODBUS RTU protocol. The device can only be configured as a Slave by setting Enab. on parameter 149 Mb.SL.. This function enables the control of multiple controllers connected to a supervisory system / SCADA.

Each controller responds to a Master query only if the query contains the same address as parameter 150 *Sl.Ad.* ("Slave Address").

The addresses permitted range from 1 to 254 and there must not be controllers with the same address on the same line.

Address 255 can be used by the Master to communicate with all the connected equipment (broadcast mode), while with 0 all the devices receive the command, but no response is expected.

The baud rate is selected on parameter 151 *Sl.b.r.* ("Slave Baud Rate"). The serial format is set on parameter 152 *Sl.S.P.F.* ("Slave Serial Port Format")

ATR144 can introduce a delay (in milliseconds) of the response to the master request. This delay must be set on parameter 153 *Sl.dE.* ("Serial Delay").

Each parameter modification is saved by the controller in the EEPROM memory (100000 writing cycles), while the setpoints are saved with a delay of 10 seconds after the last modification.

Changes made to words that are different from those reported in the following table can lead to malfunction.

Modbus RTU protocol features		
Baud-rate	Selectable on parameter 151 <i>Sl.b.r.</i>	
	1200bit/s	28800bit/s
	2400bit/s	38400bit/s
	4800bit/s	57600bit/s
	9600bit/s	115200bit/s
	19200bit/s	



Modbus RTU protocol features	
Format	Selectable on parameter 152 5.5.P.F. 8N1 8N2 8E1 8E2 8O1 8O2
Supported functions	WORD READING (max 50 word) (0x03, 0x04) SINGLE WORD WRITING (0x06) MULTIPLE WORDS WRITING (max 50 word) (0x10)

Here below a list of all available addresses and supported functions:

RO = Read Only	R/W = Read/Write	WO = Write Only
----------------	------------------	-----------------

Modbus address	Description	Read Write	Reset value
0	Device type	RO	47x
1	Software version	RO	Flash
2	Boot version	RO	Flash
3	Slave Address	RO	Eepr/dip
6	Baud rate	RO	Eepr/dip
50	Slave address automatic learning	WO	-
51	System code comparison for slave address automatic learning	WO	-
500	Loading default values (write 9999)	RW	0
501	Restart ATR144 (write 9999)	RW	0
502	Setpoint storing delay time	RW	10
503	Parameters storing delay time	RW	1
701	First character of the custom alarm message 1	RW	"u"
...		RW	-

Modbus address	Description	Read Write	Reset value
723	Last character of the custom alarm message 1	RW	0
751	First character of the custom alarm message 2	RW	"u"
...		RW	-
773	Last character of the custom alarm message 2	RW	0
1000	AI1 value (degrees with tenth)	RO	-
1001	Real setpoint (gradient)	RO	0
1002	Alarms status (0=absent, 1=present) Bit0 = Alarm 1 Bit1 = Alarm 2	RO	0
1003	Error flags 1 Bit0 = AI1 process error (sensor 1) Bit1 = Cold junction error Bit2 = Safety error Bit3 = Generic error Bit4 = Hardware error Bit5 = Errore L.B. Bit6 = Parameters out of range error Bit7= CPU eeprom writing error Bit8= RFid eeprom writing error Bit9= CPU eeprom reading error Bit10= RFid eeprom reading error Bit11= Eeprom calibrations bench corrupted Bit12= Eeprom constants bench corrupted Bit13 = Missing calibrations error Bit14 = Eeprom CPU bench parameters corrupted Bit15 = Eeprom CPU setpoint bench corrupted	RO	0

Modbus address	Description	Read Write	Reset value
1004	Error flags 2 Bit0 = Rfid memory not formatted Bit1 = Eeprom CPU logo bench corrupted Bit2 = Modbus Master error	RO	0
1005	Digital inputs status (0=not active, 1=active) Bit0 = Digital input 1 Bit1 = Digital input 2	RO	0
1006	Outputs status (0=off, 1=on) Bit 0 = Q1 Bit 1 = Q2 Bit 4 = DO1	RO	0
1007	Led status (0=off, 1=on) Bit 0 = Led C Bit 1 = Led T Bit 2 = Led R Bit 3 = Led A1 Bit 4 = Led A2 Bit 5 = Led M Bit 7 = Led point time 2 Bit 8 = Led point time 1	RO	0
1008	Key status (0=released, 1=pressed) Bit 0 = Key  arrow Bit 2 = Key FNC Bit 1 = Key  arrow Bit 3 = Key SET	RO	0
1009	Cold junction temperature (degrees with tenth)	RO	-
1100	All value with decimal point selection	RO	-
1101	Real setpoint (gradiente) with decimal point selection	RO	0

Modbus address	Description	Read Write	Reset value
1200	Setpoint 1 of regulation loop 1 (degrees with tenth)	R/W	EEPROM
1201	Setpoint 2 of regulation loop 1 (degrees with tenth)	R/W	EEPROM
1202	Setpoint 3 of regulation loop 1 (degrees with tenth)	R/W	EEPROM
1203	Setpoint 4 of regulation loop 1 (degrees with tenth)	R/W	EEPROM
1204	Alarm 1 setpoint (degrees with tenth) Alarm 1 setpoint upper if Par. 62 AL.1.F. = A.band	R/W	EEPROM
1205	Alarm 1 setpoint lower if Par. 62 AL.1.F. = A.band (degrees with tenth)	R/W	EEPROM
1206	Alarm 2 setpoint (degrees with tenth) Alarm 2 setpoint upper if Par. 78 AL.2.F. = A.band	R/W	EEPROM
1207	Alarm 2 setpoint lower if Par. 78 AL.2.F. = A.band (degrees with tenth)	R/W	EEPROM
1208	Start/Stop 0=controller in STOP 1=controller in START	R/W	0
1209	Hold conversion ON/OFF 0=Hold conversion OFF 1=Hold conversion ON	R/W	0

Modbus address	Description	Read Write	Reset value
1210	Tune management		
	With automatic Tune (par. 36 $t_{un.l} = R_{uto}$): 0=autotunig function OFF 1=autotuning ON	RO	0
	With manual Tune (par. 36 $t_{un.l} = P_{Rnu.o} \text{ ONCE}$): 0=autotunig function OFF 1=autotuning ON	R/W	0
	With synchronized Tune (par. 36 $t_{un.l} = S_{ynch}$): 0=autotunig function OFF 1=command output OFF (forces the cooling) 2=command output ON (forces the heating) 3=autotuning ON 4=autotuning ended	R/W	0
1211	Automatic/manual selection 0=automatic; 1=manual	R/W	0
1212	Command output percentage (0-10000) Heating output percentage with regulation in double loop (0-10000)	R/W	0
1213	Command output percentage (0-1000) Heating output percentage with regulation in double loop (0-1000)	R/W	0
1214	Command output percentage (0-100) Heating output percentage with regulation in double loop (0-100)	R/W	0

Modbus address	Description	Read Write	Reset value
1215	Cooling output percentage with regulation in double loop (0-10000)	RO	0
1216	Cooling output percentage with regulation in double loop (0-1000)	RO	0
1217	Cooling output percentage with regulation in double loop (0-100)	RO	0
1218	Command output manual reset: write 0 to reset the command output. In reading 0=reset not allowed, 1=reset allowed	R/W	0
1219	Alarms manual reset: write 0 to reset all alarms. In reading 0=reset not allowed, 1=reset allowed Bit0 = Alarm 1 Bit1 = Alarm 2	R/W	0
1220	Alarm 1 remote status (0=absent, 1=present)	R/W	0
1221	Alarm 2 remote status (0=absent, 1=present)	R/W	0
1222	Tare of zero AI1 (1=tare; 2=reset tare)	R/W	0
1300	Setpoint 1 of regulation loop 1, with decimal point selection	R/W	EEPROM
1301	Setpoint 2 of regulation loop 1, with decimal point selection	R/W	EEPROM
1302	Setpoint 3 of regulation loop 1, with decimal point selection	R/W	EEPROM
1303	Setpoint 4 of regulation loop 1, with decimal point selection	R/W	EEPROM

Modbus address	Description	Read Write	Reset value
1304	Alarm 1 setpoint, with decimal point selection Alarm 1 upper setpoint if Par. 62 AL.1.F. = A.band	R/W	EEPROM
1305	Alarm 1 lower setpoint if Par. 62 AL.1.F. = A.band, with decimal point selection	R/W	EEPROM
1306	Alarm 2 setpoint, with decimal point selection Alarm 2 upper setpoint if Par. 78 AL.2.F. = A.band	R/W	EEPROM
1307	Alarm 2 lower setpoint if Par. 78 AL.2.F. = A.band, with decimal point selection	R/W	EEPROM
1400	Remote process reset: by writing 1, the ATR144 uses for the process the value measured by the analogue input instead of the one written in the word 1401	W	-
1401	Remote process. The number written in this word will be the process value that the device uses for setting and alarms (ADC disabled)	W	-
2001	Parameter 1	R/W	EEPROM
2002	Parameter 2	R/W	EEPROM
...	Parameter ...	R/W	EEPROM
2223	Parameter 223	R/W	EEPROM

8.2 Master

The device works as master if value selected on parameter 160 Пб.ПР. is other than d 15Rb.

8.2.a Master mode in retransmission

In this mode the device may write up to two values on a target (slave) with ID equal to the value set on the parameter 161 *t.A.Ad.* ("Target Address"). BaudRate and serial format will have to be set on the parameters 162 *M.B.R.* ("Master Baud Rate") and 163 *M.S.P.F.* ("Master Serial Port Format"). The variables to be resent are chosen on the parameters 164 *v.A.r.1* and 169 *v.A.r.2*: the addresses for reading/writing the variables should be set on the parameter 165 *v.1.Ad.* ("Variable 1 Address") for variable 1 and parameter 170 *v.2.Ad.* ("Variable 2 Address") for variable 2. For resending the setpoints (parameters 164 *v.A.r.1* or 169 *v.A.r.2* set to *P.W.c.SE.* or *P.W.A.1.S.*) after writing on the slave, the ATR144 starts reading the word that has been chosen: in this way any change of the slave value is also registered by the master. Two subsequent queries are delayed by the time set on the parameter 174 *t.r.dE.* ("Transmission Delay"), while the response from the slave is expected for a max. time set on the parameter 175 *r.E.tO.* ("Reception Timeout"). The following table shows the choices which allow the master operation during resending.

<i>v.A.r.1</i> <i>v.A.r.2</i>	Description
<i>U.Pro.</i> Write Process	Write the process value
<i>r.U.c.SE.</i> Read/Write Command Setpoint	Read and Write the command setpoint value
<i>U.c.o.u.P.</i> Write Command Output Percentage	Write the output percentage calculated by the P.I.D. (Range 0-10000)
<i>r.U.A.1.S.</i> Read/Write Alarm 1 Setpoint	Read and Write the alarm 1 setpoint value
<i>U.conS.</i> Write Constant	Write the parameter value 168 <i>con.1</i> or 173 <i>con.2</i>

The read/written value might be rescaled according to the proportion described in the following table:

$uAr.1$ or $uAr.2$	Value limits input		Limits of rescaled value	
	Min	Max	Min	Max
$U.Pro.$ Write Process	$LL.1.1$ Lower Limit Input 1	$UL.1.1$ Upper Limit Input 1	$LL.v.10$ $LL.v.2$ Lower Limit Variable x	$UL.v.10$ $UL.v.2$ Upper Limit Variable x
$r.U.c.SE.$ Read/Write Command Setpoint	$LL.5.1$ Lower Limit Command Setpoint	$UL.5.1$ Upper Limit Command Setpoint	$LL.v.10$ $LL.v.2$ Lower Limit Variable x	$UL.v.10$ $UL.v.2$ Upper Limit Variable x
$U.c.o.u.P.$ Write Command Output Percentage	0	10000	$LL.v.10$ $LL.v.2$ Lower Limit Variable x	$UL.v.10$ $UL.v.2$ Upper Limit Variable x
$r.U.A.15.$ Read/Write Alarm 1 Setpoint	$A.LL.$ Alarm 1 Lower Limit	$A.UL.$ Alarm 1 Upper Limit	$LL.v.10$ $LL.v.2$ Lower Limit Variable x	$UL.v.10$ $UL.v.2$ Upper Limit Variable x

The input value (included between minimum and max limit) is linearly converted into the retransmitted value which is included between min and max output value. Rescaling is not executed if parameters $LL.v.1$, e , $UL.v.1$ or $LL.v.2$ have the same value.

8.2.b Master Mode Remote process

To enable this function it is necessary to select $r.P_{r.o.}$ on parameter 164 $\nu R.r.l.$ In this mode the ATR144 reads a value remotely and sets it as a process. The read value might be rescaled according to the proportion described in the following table:

$\pi A S E.$	Limits of read value		Limits of rescaled value	
	Min	Max	Min	Max
$r. P_{r.o.}$ Read Process	$L.L.\nu.l$ Lower Limit Variable 1	$\nu.L.\nu.l$ Upper Limit Variable 1	$L.L. r.l$ Lower Limit Input 1	$\nu.L. r.l$ Upper Limit Input 1

8.2.c Master reading mode CT 2000.35.014

To enable this operation, $E_{n.c.t}$ should be set on the parameter 160 $\pi b.\pi R.$ If you connect the current transformer to the serial port, you may read the RMS current absorbed by the load and show it on display 2 by setting $R_{M.S.c.u.}$ on the parameter 123 $\nu i.d.z.$

8.2.d Master reading mode CT 2000.35.014 as amperometer

To enable this operation, $E_{n.c.t.R.}$ should be set on the parameter 160 $\pi b.\pi R.$

If you connect the current transformer to the serial port, the RMS current measured will be the process of the ATR144: by means of this mode the device will become an ammeter.

9 Reading and configuration through NFC



Scan the Qr-Code to download the App on Google Play Store®

The controller ATR144 is supported by the App MyPixsys: using an ANDROID smartphone with NFC connection it is possible to program the device without using a dedicated equipment. The App allows to read, set and backup all parameters which are stored into the internal memory of Pixsys devices.

Procedure:

- Identify the position of the NFC antenna on the smartphone (usually central, behind the back cover) or to one of the sides in case of metal chassis. The ATR144's antenna is placed on the frontal panel, under the UP arrow keys.
- Make sure that the NFC sensor of the phone is enabled or that there are no metal materials between the phone and the device (ex. aluminium cover or with magnetic stand)
- It is useful to enable the system sounds on the smartphone, as the notification sound confirms that the device has correctly been detected.

The App interface is provided with four tabs: SCAN, DATA, WRITE, EXTRA.

Select the first tab "SCAN" to read data stored into the internal memory of the device; place the smartphone in contact with

the controller frontal panel, making sure that the phone's antenna matched with that of the controller.

Once detected the device, the App emits a notification sounds and proceeds with the model identification and the reading of the parameters.

The graphic interface shows the advancement and switches to the second tab "DATA". It is now possible to move the smartphone away from the controller to make the required modifications more easily.

The device parameters are divided into collapsible groups and are displayed with name, current value and reference index to the manual.







Click on a row to open the setting screen of the related parameter with the detailed view of available options (in case of multiple choice parameters) or of the minimum/maximum/decimals limits (for numeric parameters), included the text description (as per section n. 15 of the user manual). Once selected the chosen value, the related row will be updated and underlined into the tab "DATA" (hold down the line to cancel modifications).

To download the new configuration on your device, select the third tab "WRITE", place again the smartphone in contact with the controller and wait for the notification.

The ATR144 will show a restart request, necessary to update the configuration with the new written modifications; if it does not restart, the ATR144 will continue to work with the previous configuration.

In addition to the classic operation of parameters reading->modification->writing, MyPixsys is provided with additional functions which can be accessed by the tab "EXTRA", as save parameters / share loaded values/ restore default values.

10 Access configuration

	Press	Display	Do
1	FNC for 3 sec.	Display 1 shows <i>PASS.</i> , while display 2 shows <i>0000</i> with the 1st digit flashing.	
2		Modify flashing digit and move to next digit with SET .	Enter password <i>1234</i> .
3	FNC to confirm	Display 1 shows the first parameters group, display 2 shows the description.	
4	 or 	Scroll parameters groups.	
5	SET to confirm	Display 1 shows the first parameter of the group and display 2 shows its value.	Press FNC to exit configuration.
6	 or 	Scroll parameters.	
7	SET to confirm	Allows parameter modification (display 2 flashes)	
8	 or 	Increases or decreases visualized value	Introduce new data
9	SET	Confirms and stores the new value.	
10	FNC	Backs to parameter groups selection (see point 3).	Press again FNC to exit configuration

10.1 Loading default values

This procedure allows to restore factory settings of the device.

	Press	Display	Do
1	FNC for 3 sec	Display 1 shows <i>PASS.</i> , while display 2 shows <i>0000</i> with the 1st digit flashing.	
2	▲ or ▼	Modify the flashing digit and move to the next one pressing SET .	Enter password <i>9999</i> .
3	FNC to confirm	The device loads default settings and restarts.	

10.2 Parameters list functioning

The controller ATR144 integrates many features that make the configuration parameters list very long. To make it more functional, the parameters list is dynamics and it changes as the user enables / disables the functions. Practically, using a specific function that occupies a given input (or output), the parameters referred to other functions of that resource are hidden to the user making the parameters list more concise. To simplify the reading/interpretation of the parameters, pressing **SET** it is possible to visualize a brief description of the selected parameter.

Finally, keeping pressed **FNC**, it is possible to move from the mnemonic visualization of the parameter to the numeric one, and vice versa. Ex. The first parameter can be displayed as *SEn.1* (mnemonic visualization) or as *P.001* (numeric visualization)

11 Table of Configuration Parameters

11.a GROUP A - *A_{in.1}* - Analogue input 1

1	<i>SEN.1</i>	Sensor AI1
		Analogue input configuration / sensor AI1 selection
<i>t.c. K</i>	Tc-K	-260° C..1360° C. (Default)
<i>t.c. S</i>	Tc-S	-40° C..1760° C
<i>t.c. R</i>	Tc-R	-40° C..1760° C
<i>t.c. J</i>	Tc-J	-200° C..1200° C
<i>t.c. t</i>	Tc-T	-260° C..400° C
<i>t.c. E</i>	Tc-E	-260° C..980° C
<i>t.c. N</i>	Tc-N	-260° C..1280° C
<i>t.c. b</i>	Tc-B	100° C..1820° C
<i>Pt100</i>	Pt100	-200° C..600° C
<i>Ni100</i>	Ni100	-60° C..180° C
<i>Ni120</i>	Ni120	-60° C..240° C
<i>Ntc 1</i>	NTC 10K β 3435K	-40° C..125° C
<i>Ntc 2</i>	NTC 10K β 3694K	-40° C..150° C
<i>Ntc 3</i>	NTC 2252 β 3976K	-40° C..150° C
<i>Ptc</i>	PTC 1K	-50° C..150° C
<i>Pt500</i>	Pt500	-200° C..600° C
<i>Pt1k</i>	Pt1000	-200° C..600° C
<i>RS/d.1</i>	Reserved	
<i>RS/d.2</i>	Reserved	
<i>0-1</i>	0..1 V	
<i>0-5</i>	0..5 V	
<i>0-10</i>	0..10 V	
<i>0-20</i>	0..20 mA	
<i>4-20</i>	4..20 mA	
<i>0-60</i>	0..60 mV	
<i>Pot.</i>	Potentiometer (set the value on parameter 6)	

- 2** *d.P. 1* **Decimal Point 1**
 Select number of displayed decimal points for AI1
 0 **Default**
 0.0 1 decimal
 0.00 2 decimals
 0.000 3 decimals
- 3** *dEGr.* **Degree**
 °C Celsius degree (**Default**)
 °F Fahrenheit degree
 K Kelvin degree
- 4** *LL.i.1* **Lower Linear Input AI1**
 AI1 lower limit only for linear signals. Ex.: with input 4..20 mA this parameter takes value associated to 4 mA. The value may be greater than the one entered on the next parameter.
 Lower limit for termination, in case of process transmission in modbus master.
 -9999..+30000 [digit^{1 p. 86}] **Default: 0.**
- 5** *UL.i.1* **Upper Linear Input AI1**
 AI1 upper limit only for linear signals Ex: with input 4..20 mA this parameter takes value associated to 20 mA. The value may be lower than the one entered on the previous parameter.
 Upper limit for termination, in case of process transmission in modbus master.
 -9999..+30000 [digit^{1 p. 86}] **Default:1000**
- 6** *P.uA.1* **Potentiometer Value AI1**
 Selects the value of the potentiometer connected on AI1
 1..150 kohm. **Default: 10kohm**

- 7** *i.o.L.1* **Linear Input over Limits AI1**
 If AI1 is a linear input, allows the process to bypass the limits (Par. 4 and 5).
d.SRb. Disabled (**Default**)
ENRb. Enabled
- 8** *o.c.R.1* **Offset Calibration AI1**
 AI1 Offset calibration. Value added/subtracted to the process value (ex: usually correcting the ambient temperature value).
 -9999..+9999 [digit¹ p. 86] (degrees.tenths for temperature sensors). **Default** 0.
- 9** *G.c.R.1* **Gain Calibration AI1**
 Value multiplied to the process value to calibrate the working point. Ex: to correct the range from 0..1000°C showing 0..1010°C, set the parameter to -1.0
 -100.0%..+100.0%, **Default:** 0.0.
- 10** *L.t.c.1* **Latch-On AI1**
 Automatic setting of limits for AI1 linear input.
d.SRb. Disabled. (**Default**)
StMPrd Standard
V.O.Sto. Virtual Zero Stored
V.O.t.oN. Virtual Zero at start
- 11** *c.F.L.1* **Conversion Filter AI1**
 ADC Filter: Number of sensor readings to calculate mean that defines process value. NB: when readings increase, control loop speed slows down.
 1..15. (**Default:** 10)

12 *cFr.1* Conversion Frequency A11

Sampling frequency of digital / analogue converter for A11. Increasing the conversion speed will slow down reading stability (example: for fast transients, as the pressure, it is advisable to increase sampling frequency)

4.17.KZ 4.17 Hz (Min. conversion speed)

6.25KZ 6.25 Hz

8.33KZ 8.33 Hz

10.0KZ 10.0 Hz

12.5KZ 12.5 Hz

16.7KZ 16.7 Hz (**Default**) Ideal for filtering noises 50 / 60 Hz

19.6KZ 19.6 Hz

33.2KZ 33.2 Hz

39.0KZ 39.0 Hz

50.0KZ 50.0 Hz

62.0KZ 62.0 Hz

123KZ 123 Hz

242KZ 242 Hz

470KZ 470 Hz (Max. speed conversion)

13÷17 Reserved Parameters - Group A

Reserved parameters - Group A

11.b GROUP B - *cPd.1*- Outputs and regulation Process 1

18 *c.Ou.1* Command Output 1

Selects the command output related to the process1 and the outputs related to the alarms.

c. o2 Command on relay output Q2.

c. o1 Command on relay output Q1. (**Default**)

c. SSR Command on digital output.

c. VRL Servo-valve command with open loop.

ATR144-ABC	Command	AL. 1	AL. 2
c. a2	Q2	Q1	DO1
c. a1	Q1	Q2	DO1
c. SSP	DO1	Q1	Q2
c. VRL.	Q1(open) Q2(close)	DO1	-

ATR144-ABC-T	Command	AL. 1
c. a1	Q1	DO1
c. SSP	DO1	Q1
c. VRL.	Q1(open) DO1(close)	-

19 *Ac.t.1* Action type 1

Action type to control process 1.

HEAT Heating (N.A.) (**Default**)

cool Cooling (N.C.)

20 *c.HY.1* Command Hysteresis 1

Sets the hysteresis value used for process control during ON/OFF functioning

-9999..+9999 [digit^{1 p. 86}] (degrees.tenths for temperature sensors). **Default** 0.2.

21 *L.L.S.1* Lower Limit Setpoint 1

Lower limit setpoint selectable for command setpoint 1.

-9999..+30000 [digit^{1 p. 86}] (degrees.tenths for temperature sensors). **Default** 0.

22 *u.L.S.1* Upper Limit Setpoint 1

Upper limit setpoint selectable for command setpoint 1.

-9999..+30000 [digit^{1 p. 86}] (degrees for temperature sensors). **Default** 1750.

23 *c.rE.1* Command Reset 1

Type of reset for command contact 1 (always automatic in P.I.D. functioning)

R.RES. Automatic Reset (**Default**)

M.RES. Manual Reset (by keyboard or by digital input).

M.RES.S. Manual Reset Stored (keeps relay status also after an eventual power failure).

R.RES.t. Automatic reset with timed activation. The command remains active for the time set on the parameter *c.dE.l.*, even if the conditions generating it are missing. To be able to act again, the conditions for activating the command must disappear.

24 *c.S.E.1* Command State Error 1

State of contact for command 1 output in case of error.

If the command output 1 (Par. 18 *c.O.U.1*) is relay or valve:

oPEN Contact or valve open. **Default**

cLoSE Contact or valve closed.

If the command output is digital output (SSR):

oFF Digital output OFF. **Default**

oN Digital output ON.

25 *c.l.d.1* Command Led 1

Defines led C1 state corresponding to the related output. If the valve command is selected, this parameter is not managed.

o.c. ON with open contact or SSR switched off.

c.c. ON with closed contact or SSR switched on. (**Default**)

26 *c.dE.1* **Command Delay 1**

Command 1 delay (only in ON / OFF functioning).
-60:00..60:00 mm:ss. **Default:** 00:00.
Negative: delay when turning off output.
Positive: delay when turning on output.

27 *c.SP.1* **Command Setpoint Protection 1**

Controls access to the command setpoint 1 value

<i>FREE</i>	Modification allowed (Default)
<i>Lock</i>	Protected
<i>Hide</i>	Protected and not displayed

28 *v.Rt.1* **Valve Time 1**

Valve time related to command 1 (declared by the manufacturer of the valve)
1...300 seconds. **Default:** 60.

29 *A.MA.1* **Automatic / Manual 1**

Enables the automatic/manual selection for command 1

<i>d.SPb.</i>	Disabled (Default)
<i>ENAb.</i>	Enabled
<i>EN.Sto.</i>	Enabled with memory

30 *in.i.S.* **Initial State**

Choose the state of the controller when turning it on. This only works on the version ATR144-ABC-T or by enabling the Start/Stop from digital input or **SET** button.

<i>START</i>	Start (Default)
<i>Stop</i>	Stop
<i>StoPE.</i>	Stored. State of Start/Stop prior to switching off.

31÷35 **Reserved Parameters - Group B**

Reserved parameters - Gruppo B

11.c GROUP C - rEE.1 - Autotuning and PID 1

36 *tun.1* Tune 1

Selects autotuning type for command 1.

dSPb. Disabled. If proportional band and integral time parameters are to set to zero, the regulation is ON/OFF type.. (**Default**)

Auto Automatic (Automatic P.I.D. parameters calculation)

MANU. Manual (launch by keyboards or by digital input)

once Once (P.I.D. parameters calculation only at first start)

SYNCH. Synchronized (Autotuning managed by serial)

37 *S.d.t.1* Setpoint Deviation Tune 1

Selects deviation from command setpoint 1 as threshold used by autotuning to calculate P.I.D. parameters.

0-10000 [digit^{1 p. 86}] (degrees.tenths for temp. sensors).

Default: 30.0.

38 *P.b. 1* Proportional Band 1

Proportional band or process 1 P.I.D. regulation (Process inertia).

0 ON / OFF if t.i. equal to 0 (**Default**)

1..10000 [digit^{1 p. 86}] (degrees.tenths for temp. sensors).

39 *i.t. 1* Integral Time 1

Integral time for process P.I.D. regulation (process inertia duration).

0.0...2000.0 sec. (0.0 = integral disabled), **Default** 0.0

40 *d.t. 1* Derivative Time 1

Derivative time for process P.I.D. regulation (Normally ¼ of integral time).

0.0...1000.0 sec. (0.0 = derivative disabled), **Default** 0

- 41** *d.b. 1* **Dead Band 1**
 Dead band of process 1 P.I.D.
 0..10000 [digit^{1 p. 86}] (degrees.tenths for temp. sensors)
(Default: 0)
- 42** *P.b.c.1* **Proportional Band Centered 1**
 Defines if the proportional band must be centered or not on the setpoint. In double loop functioning (heating/cooling), always disabled.
d.5Pb. Disabled. Band under (heating) or over (cooling)**(Default)**
ENPb. Centered band
- 43** *o.o.S.1* **Off Over Setpoint 1**
 In P.I.D. enables the command output switching off, when a certain threshold is exceeded (setpoint + Par.44)
d.5Pb. Disabled **(Default)**
ENPb. Enabled
- 44** *o.d.t.1* **Off Deviation Threshold 1**
 Sets deviation from command setpoint, used to calculate the intervention threshold for "Off Over Setpoint 1" function.
 -9999..+9999 [digit^{1 p. 86}] (degrees.tenths for temperature sensors) **(Default: 0)**
- 45** *c.t. 1* **Cycle Time 1**
 Cycle time for P.I.D. regulation of process 1 (for P.I.D. on remote control switch 15 s; for PID on SSR 2s). For valve refer to parameter 28 *uP.t.1*
 1-300 seconds **(Default:15 sec.)**
- 46** *co.F.1* **Cooling Fluid 1**
 Type of refrigerant fluid for heating/cooling P.I.D. for process. Enable the cooling output on parameter AL.1 or AL.2.
Air Air **(Default)**
Oil Oil
WATER Water

- 47** *P.b.1* **Proportional Band Multiplier 1**
Proportional band multiplier for heating/cooling P.I.D. for process 1. Proportional band for cooling action is given by parameter *P.b. 1* multiplied for this value 1.00...5.00. **Default: 1.00**
- 48** *o.d.b.1* **Overlap / Dead Band 1**
Dead band combination for heating / cooling P.I.D. (double action) for process 1.
-20.0%...50.0%
Negative: Dead band.
Positive: overlap. **Default: 0.0%**
- 49** *c.c.t.1* **Cooling Cycle Time 1**
Cycle time for cooling output in heating/cooling P.I.D. mode for process.
1-300 seconds (**Default: 10 sec.**)
- 50** *LLP.1* **Lower Limit Output Percentage 1**
Selects min. value for command output percentage.
0%...100%, **Default: 0%**.
- 51** *u.L.P.1* **Upper Limit Output Percentage 1**
Selects max. value for command output percentage.
0%...100%, Default: 100%.
- 52** *π.G.E.1* **Max Gap Tune 1**
Sets the max. process-setpoint allowed gap before the automatic tune recalculates PID parameters of the process.
0-10000 [digit^{1 p. 86}] (degrees.tenths for temp. sensors).
Default: 2.0
- 53** *π.n.P.1* **Minimum Proportional Band 1**
Selects the min. proportional band 1 value selectable by the automatic tune for the P.I.D. regulation of process.
0-10000 [digit^{1 p. 86}] (degrees.tenths for temp. sensors).
Default: 3.0

54 ПР.Р.1 Maximum Proportional Band 1

Selects the max. proportional band 1 value selectable by the automatic tune for the P.I.D. regulation of process.

0-10000 [digit^{1 p. 86}] (degrees.tenths for temp. sensors).
Default: 80.0

55 ПИ.Т.1 Minimum Integral Time 1

Selects the min. integral time 1 value selectable by the automatic tune for the P.I.D. regulation of process.

0.0...1000.0 seconds. **Default: 30.0 sec.**

56 О.С.Л.1 Overshoot Control Level 1

The overshoot control function prevents said event from happening during startup or upon modification of the setpoint. Setting this value too low could cause the overshoot to not be fully absorbed, while higher values might increase the time needed to reach the setpoint.

Disab.	Lev. 4	Lev. 8
Lev. 1	Lev. 5 (Def.)	Lev. 9
Lev. 2	Lev. 6	Lev. 10
Lev. 3	Lev. 7	

57÷61 Reserved Parameters - Group C

Reserved parameters - Group C.

11.d GROUP D - РЛ. 1 - ALARM 1

62 РЛ.1.Ф. Alarm 1 Function

Auxiliary for job distribution of the command output. Cyclically replaces the command output for the time set on parameter 70 Р.1.дЕ.. If Р.1.дЕ. = 0 is activated in parallel with the command output. It does not work in case of valve control and can only be activated on an alarm if Р.1.дЕ. is different from 0.

д.5Рб. Disabled (**Default**)

Рб.уР.Р. Absolute Upper Activation. Absolute referred to the process, active over

<i>Ab.Lo.A.</i>	Absolute Lower Activation. Absolute referred to the process, active under
<i>bAlM</i>	Band alarm (command setpoint ± alarm setpoint)
<i>A.bAlM</i>	Asymmetric band alarm (command setpoint + alarm setpoint 1 H and command setpoint - alarm setpoint 1 L).
<i>uP.dE'</i>	Upper Deviation alarm
<i>Lo.dE'</i>	Lower Deviation alarm
<i>Ab.c.u.A.</i>	Absolute Command Upper Activation. Absolute alarm referred to the command setpoint, active over
<i>Ab.c.L.A.</i>	Absolute Command Lower Activation. Absolute alarm referred to the command setpoint, active under
<i>Run</i>	Status alarm (active in RUN/START)
<i>cool</i>	Cold actuator auxiliary (Cold action in double loop)
<i>c.Aux</i>	Auxiliary for job distribution on the command output. It cyclically replaces the command output for the time set on the parameter <i>A.l.dE</i> . If <i>A.l.dE</i> = 0, it is activated parallel to the command output. It does not work in case of valve control.
<i>PRb.EP.</i>	Probe error. Alarm active in case of sensor rupture.
<i>L.b.A.</i>	Loop Break Alarm (see paragraph 7.8)
<i>EMP.1</i>	Related to timer 1 (see par. 186 <i>EMP.1</i>)
<i>EMP.2</i>	Related to timer 2 (see par. 189 <i>EMP.2</i>)
<i>EMP.1.2</i>	Related to both timers
<i>d.i. 1</i>	Digital Input 1. Active when digital input 1 is active.
<i>d.i. 2</i>	Digital Input 2. Active when digital input 2 is active.
<i>REM.</i>	Remote. The alarm is enabled by the word 1220
<i>P.Aux</i>	Auxiliary 1 for cycle (programmer vers. only)

63 *A1.S.O.* Alarm 1 State Output

Alarm 1 output contact and intervention type.

N.O. St. (N.O. Start) Normally open,
active at start (**Default**)

N.c. St. (N.C. Start) Normally closed, active at start

N.O. tH. (N.O. Threshold) Normally open,
active on reaching alarm^{2 p. 86}

N.c. tH. (N.C. Threshold) Normally closed,
active on reaching alarm^{2 p. 86}

N.O.tH.V. (N.O. Threshold Variation) disabled after
changing control setpoint^{3 p. 86}

N.c.tH.V. (N.C. Threshold Variation) disabled after
changing control setpoint^{3 p. 86}

64 *A1.HY.* Alarm 1 Hysteresis

Alarm 1 hysteresis

-9999..+9999 [digit^{1 p. 86}] (degrees.tenths for temp.
sensors). **Default** 0.5.

65 *A1.L.L.* Alarm 1 Lower Limit

Lower limit selectable for the alarm 1 setpoint.

-9999..+30000 [digit^{1 p. 86}] (degrees.tenths for temp.
sensors). **Default** 0.

66 *A1.U.L.* Alarm 1 Upper Limit

Upper limit selectable for the alarm 1 setpoint

-9999..+30000 [digit^{1 p. 86}] (degrees.tenths for temp.
sensors). **Default** 1750.

67 *A1.r.E.* Alarm 1 Reset

Alarm 1 contact reset type (always autom. if *AL.I.F. = c. AWH*).

R. RES. Automatic reset (**Default**)

M. RES. Manual reset (manual reset by
SET key or by digital input)

M.RES.5. Stored manual reset (keeps the output
status also after a power failure)

R.RES.E. Automatic reset with timed activation. The alarm remains active for the time set on the parameter **R.l.dE.**, even if the conditions generating it are missing. To be able to act again, the alarm conditions must disappear.

68 **R.I.S.E.** Alarm 1 State Error

Alarm 1 output status in case of error.

If the alarm output is a relay:

oPEN Contact or valve open. **Default**

cLoSE Contact or valve closed.

If the alarm output is digital output (SSR):

oFF Digital output OFF. **Default**

oN Digital output ON.

69 **R.l.L.d.** Alarm 1 Led

Defines the status of the led **A1** in correspondence of the related output

o.c. ON with open contact or DO switched off.

c.c. ON with closed contact or DO switched on. (**Default**)

70 **R.l.dE.** Alarm 1 Delay

Alarm 1 Delay.

-60:00..60:00 mm:ss (hh:mm if AL.1.F. = **c.R.u.**). **Default:** 00:00.

Negative value: delay when leaving alarm status

Positive value: delay when triggering alarm status.

71 **R.I.S.P.** Alarm 1 Setpoint Protection

Controls access to the alarm 1 setpoint

FREE Editable by the user (**Default**)

Loc! Protected

Hi.dE Protected and hidden

72 *R.Lb.* Alarm 1 Label

Selects the message displayed in case of alarm 1 intervention.

d.SRb. Disabled. **Default 0.**

Lb. 01 Message 1 (see table on paragraph 12.1)

Lb. 16 Message 16 (see table on paragraph 12.1)

uSER.L. Custom message (modifiable by the user through the app or via modbus)

73÷77 Reserved Parameters - Group D

Reserved parameters - Group D.

11.e GROUP E - *AL. 2* - Alarm 2

78 *AL.2.F.* Alarm 2 Function

Auxiliary for job distribution of the command output. Cyclically replaces the command output for the time set on parameter 86 *R.12.dE.*. If *R.2.dE.* = 0 is activated in parallel with the command output. It does not work in case of valve control and can only be activated on an alarm if *R.2.dE.* is different from 0.

d.SRb. Disabled (**Default**)

Rb.uP.R. Absolute Upper Activation. Absolute referred to the process, active over

Rb.Lo.R. Absolute Lower Activation. Absolute referred to the process, active under

bRNd Band alarm (command setpoint ± alarm setpoint)

R.bRNd Asymmetric band alarm (command setpoint + alarm setpoint 2 H and command setpoint - alarm setpoint 2 L).

uP.dE'. Upper Deviation alarm

Lo.dE'. Lower Deviation alarm

Rb.c.u.R. Absolute Command Upper Activation. Absolute alarm referred to the command setpoint, active over

Rb.c.L.R. Absolute Command Lower Activation.

RUN	Absolute alarm referred to the command setpoint, active under Status alarm (active in RUN/START)
cool	Cold actuator auxiliary (Cold action in double loop)
c.RUN	Auxiliary for job distribution on the command output. It cyclically replaces the command output for the time set on the parameter <i>A2.dE</i> . If <i>A2.dE</i> = 0, it is activated parallel to the command output. It does not work in case of valve control.
PRb.ERR.	Probe error. Alarm active in case of sensor rupture.
L.b.R.	Loop Break Alarm. (see paragraph 7.8)
EMP.1	Related to timer 1 (see par. 186 <i>ENr.1</i>)
EMP.2	Related to timer 2 (see par. 189 <i>ENr.2</i>)
EMP.1.2	Related to both timers
d.i. 1	Digital Input 1. Active when digital input 1 is active.
d.i. 2	Digital Input 2. Active when digital input 2 is active.
REM.	Remote. The alarm is enabled by the word 1221
P.RUN	Auxiliary 2 for cycle (programmer version only)

79 A25.o. Alarm 2 State Output

Alarm 2 output contact and intervention type.

N.o. St.	(N.O. Start) Normally open, active at start (Default)
N.c. St.	(N.C. Start) Normally closed, active at start
N.o. tH.	(N.O. Threshold) Normally open, active on reaching alarm ^{2p.86}
N.c. tH.	(N.C. Threshold) Normally closed, active on reaching alarm ^{2p.86}
N.o.tH.V.	(N.O. Threshold Variation) disabled after changing control setpoint ^{3p.86}

N.C.TH.V. (N.C. Threshold Variation) disabled after changing control setpoint^{3 p. 86}

80 *A.2.H.Y.* Alarm 2 Hysteresis

Alarm 2 hysteresis

-9999..+9999 [digit^{1 p. 86}] (degrees.tenths for temperature sensors). **Default** 0.5.

81 *A.2.L.L.* Alarm 2 Lower Limit

Lower limit selectable for the alarm 2 setpoint.

-9999..+30000 [digit^{1 p. 86}] (degrees for temp. sensors). **Default** 0.

82 *A.2.U.L.* Alarm 2 Upper Limit

Upper limit selectable for the alarm 2 setpoint.

-9999..+30000 [digit^{1 p. 86}] (degrees for temp. sensors). **Default** 1750.

83 *A.2.r.E.* Alarm 2 Reset

Alarm 2 contact reset type (always automatic if *AL.2.F.* = c. *A.U.H.*).

A. RES. Automatic reset (**Default**)

M. RES. Manual reset (manual reset by **SET** key or by digital input)

M.RES.5. Stored manual reset (keeps the output status also after a power failure)

A. RES.t. Automatic reset with timed activation. The alarm remains active for the time set on the parameter *A.2.dE.*, even if the conditions generating it are missing. To be able to act again, the alarm conditions must disappear.

84 *A.2.S.E.* Alarm 2 State Error

Alarm 2 output status in case of error.

If the alarm output is relay

oPEN Contact or open valve. **Default**

cLoSE Contact or closed valve.

If the alarm output is digital (SSR):

<i>oFF</i>	Digital output OFF. Default
<i>oN</i>	Digital output ON.

85 *A2.Ld.* Alarm 2 Led

Defines the status of the led **A2** in correspondence of the related output.

<i>o.c.</i>	ON with open contact or DO switched off.
<i>c.c.</i>	ON with closed contact or DO switched on. (Default)

86 *A2.dE.* Alarm 2 Delay

Alarm 2 Delay.

-60:00..60:00 mm:ss (hh:mm if AL.2.F. = *c.Fu**). **Default: 0.**
Negative value: delay when exit alarm status.
Positive value: delay when enter alarm status

87 *A2.S.P.* Alarm 2 Setpoint Protection

Allows or not to change the alarm 2 setpoint

<i>FREE</i>	Editable by the user (Default)
<i>Lock</i>	Protected
<i>Hide</i>	Protected and not visualized

88 *A2.Lb.* Alarm 2 Label

Selects the message to be visualized in case of alarm 2 intervention

<i>d.SAb.</i>	Disabled. Default 0.
<i>Lb. 01</i>	Message 1 (see table on paragraph 12.1)
<i>Lb. 16</i>	Message 16 (see table on paragraph 12.1)
<i>uSEP.L.</i>	Message personalized (modifiable by the user through the app or via modbus)

89÷93 Reserved Parameters - Group E

Reserved parameters - Group E.

11.f GROUP F - d.i. 1 - Digital input 1

94 d.i.1.F. Digital Input 1 Function

Digital input 1 functioning.

d.SPB. Disabled (**Default**)

2t.SW. 2 Setpoints Switch

2t.SW.i. 2 Setpoints Switch Impulsive

3t.SW.i. 3 Setpoints Switch Impulsive

4t.SW.i. 4 Setpoints Switch Impulsive

5t./St. Start / Stop. Status of the controller, upon power-up, depends on parameter 30 in r.5.

Run Run. With the controller in STOP the alarms remain active.

Ext.AL. External alarm. The controller goes on STOP and the alarms will be disabled. The controller does not return to START automatically: for this operation, the user's intervention is required.

Hold Lock conversion (stop all conversions and display values)

tUNE Enable / disable tuning if the parameter 36 tUN.i is set on PAHU.

Auto.MA.i. Automatic / Manual Impulse (if enabled on parameter 29 A.PA. I)

Auto.MA.c. Automatic / Manual Contact (if enabled on parameter 29 A.PA. I)

Act.tY. Action Type. Cooling regulat. if D.I. is active, otherwise heating reg.

A.i. 0 Analogue Input 0. Set AI to zero

M. RES. Manual reset. Reset the outputs if selected as manual reset.

t.1.Run Timer 1 run. The timer 1 runs while D.I. is activated

t.1.S.E. Timer 1 Start End. D.I. starts and stops the timer 1(impulsive)

t.1.StA. Timer 1 Start. D.I. starts the timer 1(impulsive)

t.1.EnD. Timer 1 End. D.I. stops the timer 1(impulsive)

t.2.Run Timer 2 run. The timer 2 counts

- with D.I. activated
- E.2. 5.E. Timer 2 Start End. D.I. starts and stops the timer 2(impulsive)
- E.2.5EtR. Timer 2 Start. D.I. starts the timer 2(impulsive)
- E.2.5EtD. Timer 2 End. D.I. stops the timer 2(impulsive)
- Lo.cFG. Lock configuration and setpoints.
- uP.KEY. Simulates the functioning of UP key.
- doWn.K. Simulates the functioning of DOWN key.
- Fnc. K. Simulates the functioning of **FNC** key.
- SEt. K. Simulates the functioning of **SET** key (password entry excluded).

95 d.i.l.c. Digital Input 1 Contact

Defines the resting contact of the digital input 1.

- N.oPEN Normally open (**Default**)
- N.cLoS. Normally closed

96÷100 Reserved Parameters - Group F

Reserved parameters - Group F.

11.g GROUP G - d. i. 2 - Digital input 2

101 d. i. 2.F. Digital Input 2 Function

Digital input 2 functioning.

d.SRb. Disabled (**Default**)

2t.SW. 2 Setpoints Switch

2t.SW.i. 2 Setpoints Switch Impulsive

3t.SW.i. 3 Setpoints Switch Impulsive

4t.SW.i. 4 Setpoints Switch Impulsive

5t./St. Start / Stop. Status of the controller, upon power-up, depends on parameter 30 in r.5.

Run Run. With the controller in STOP the alarms remain active.

Ext.AL. External alarm. The controller goes on STOP and the alarms will be disabled. The controller does not return to START automatically: for this operation, the user's intervention is required.

Hold Lock conversion (stop all conversions and display values)

tUNE Enable / disable tuning if the parameter 36 tUN.1 is set on PAOn.

Auto.MA.i. Automatic / Manual Impulse (if enabled on parameter 29 A.PA.1)

Auto.MA.c. Automatic / Manual Contact (if enabled on parameter 29 A.PA.1)

Act.tY. Action Type. Cooling regulation if D.I. is active, otherwise heating reg.

A.i. 0 Analogue Input 0. Set AI to zero

M. RES. Manual reset. Reset the outputs if selected as manual reset.

t.1.Run Timer 1 run. The timer 1 counts with D.I. activated

t.1.S.E. Timer 1 Start End. D.I. starts and stops the timer 1(impulsive)

t.1.StA. Timer 1 Start. D.I. starts the timer 1(impulsive)

t.1.End Timer 1 End. D.I. stops the timer 1(impulsive)

t.2.Run Timer 2 run. The timer 2 counts

- with D.I. activated
- Ł.2. 5.E. Timer 2 Start End. D.I. starts and stops the timer 2(impulsive)
- Ł.2.5ŁR. Timer 2 Start. D.I. starts the timer 2(impulsive)
- Ł.2.5Łd. Timer 2 End. D.I. stops the timer 2(impulsive)
- Ł.Ł.cŁG. Lock configuration and setpoints
- Ł.P.ŁEY. Simulates the functioning of UP key.
- Ł.Ł.ŁŁ.Ł. Simulates the functioning of DOWN key.
- Ł.Ł.c. Ł. Simulates the functioning of **FNC** key.
- Ł.Ł. Ł. Simulates the functioning of **SET** key (password entry excluded).

102 d.Ł.c. Digital Input 2 Contact

Defines the resting contact of the digital input 2.

- Ł.Ł.ŁPEN Normally open (**Default**)
- Ł.Ł.cŁŁS. Normally closed

103÷107 Reserved Parameters - Group G

Reserved parameters - Group G.

11.h GROUP H - 5ŁŁ.5 - Soft-start and mini cycle

108 d.Ł.ŁŁ. Delayed Start

To set the initial waiting time for the delayed start of the setting or cycle, even in case of a blackout. The elapsed time is saved every 10 minutes.

- 0 Initial waiting time disabled: the controller starts immediately (**Default**)
- 00:01-24:00 hh.mm Initial waiting time enabled.

109 Pr.cŁ. Pre-programmed Cycle

Enables special functionings.

- d.Ł.ŁRb. Disabled (**Default**)
- Ł.Ł.ŁRb. Enabled (all remote sepoint functions are inhibited)

- 110** *SS.tY.* **Soft-Start Type**
 Enables and selects the soft-start type
d.SPb. Disabled (**Default**)
GPA.d. Gradient
PER.c. Percentage (with only pre-programmed cycle disabled)
- 111** *SS.Gr.* **Soft-Start Gradient**
 Rising/falling gradient for soft-start and pre-programmed cycle.
 0..20000 Digit/hour (degrees.tenths/hour if temperature). (**Default**: 100.0)
- 112** *SS.PE.* **Soft-Start Percentage**
 Output percentage during soft-start function.
 0..100%. (**Default**: 50%)
- 113** *SS.tH.* **Soft-Start Threshold**
 Threshold under which the soft-start percentage function is activated, at starting.
 -9999..30000 [digit¹ p. 86] (degrees.tenths for temperature sensors) (**Default**: 1000)
- 114** *SS.t.t.* **Soft-Start Time**
 Max. Softstart duration: if the process will not reach the threshold selected on par. *SS.tH.* within the selected time, the controller starts to regulate on setpoint.
 00:00 Disabled
 00:01-24:00 hh:mm (**Default**: 00:15)
- 115** *MA.t.t.* **Maintenance Time**
 Maintenance time for pre-programmed cycle.
 00:00-24:00 hh.mm (**Default**: 00:00)

116	FRGr.	Falling Gradient
		Falling gradient for pre-programmed cycle.
	0	Disabled (Default)
	1..10000	Digit/hour ^{1 p. 86} (degrees.tenths/ hour if temperature)

117÷121 **Reserved Parameters - Group H**

Reserved parameters - Group H

11.i **GROUP I - dISP. - Display and interface**

122	uFlt	Visualization Filter
	dSRb.	Disabled
	PtCHf	Pitchfork filter (Default)
	F1.oPd.	First Order
	F1.oPd.P.	First Order with Pitchfork
	2 SR.M.	2 Samples Mean
n Samples Mean
	10 SR.M.	10 Samples Mean

123	u1.d2	Visualization Display 2
		Selects visualization on display 2.
	c.1.SP1	Command 1 setpoint (Default)
	ou.PE.1	Percentage of command output 1
	RMS.cu.	RMS current (if the master function CT 2000.35.014 is enabled).

124	tNo.d.	Timeout Display
		Determines the display timeout
	dSRb.	Disabled. Display always ON (Default)
	15 S	15 seconds
	1 MIN	1 minute
	5 MIN	5 minutes
	10 MIN	10 minutes
	30 MIN	30 minutes
	1 H	1 hour

125 *Тпо.5.* **Timeout Selection**

Selects which display is switched off when Display Timeout expires

- d.SP.1* Display 1
- d.SP.2* Display 2 (**Default**)
- d.SP.1.2* Display 1 and 2
- d.l.2.Ld.* Display 1, 2 and led

126 *УПР.с.* **User Menu Pre-Programmed Cycle**

Allows modification to the rising/falling gradient and retention time from the user menu (during the pre-programmed cycle functioning). To modify the parameters, press **SET**.

- d.SP.b.* Disabled (**Default**)
- R.S.GP.* Only rising gradient
- MR.t.* Only retention time
- R.G.M.t.* Rising gradient and retention time
- FRL.GP* Only falling gradient
- R.FR.G.* Rising and falling gradient
- FR.G.M.t.* Falling gradient and retention time
- R.F.G.M.t.* Rising gradient, retention time and falling gradient

127 *ScL.t.* **Scrolling Time**

Selects the timeout for the user menu data visualization, before returning to the default page

- 3 S* 3 seconds
- 5 S* 5 seconds (**Default**)
- 10 S* 10 seconds
- 30 S* 30 seconds
- 1 M.N* 1 minutes
- 5 M.N* 5 minutes
- 10M.N* 10 minutes
- MAN.Sc.* Manual scroll

- 128** *d.SPF.* **Display Special Functions**
d.SPB. Special functions disabled
SWAP Shows the setpoint on display 1 and the process on display 2 (only if Par. 123 *u.i.d.2* set on *c.ISPu*)
- 129** *nFc.L.* **NFC Lock**
 Disables NFC capabilities
d.SPB. NFC lock Disabled: behaviour, the device can be programmed via NFC using the MyPixsys smartphone app. **(Default)**
ENAB. NFC lock Enabled: NFC protection active, the device will ignore any configuration update written through nfc.
- 130** *S.F.S.F.* **Set key special functions**
 Assign special functions to the **SET** button. To execute the function the key must be pressed for 1 s.
d.SPB. No special function linked to the **SET** key. **(Default)**
St./St. Start/Stop. Pressing **SET** key the controller switches from Start to Stop and vice versa. Status of the controller, upon power-up, depends on parameter 30 *in i.5*.
2t.SW. 2 Threshold Switch. The controller changes the regulation setpoint alternating between Set1 and Set2
3t.SW. 3 Threshold Switch. The controller changes the regulation setpoint alternating between Set1, Set2 and Set3
4t.SW. 4 Threshold Switch. The controller changes the regulation setpoint alternating between Set1, Set2, Set3 and Set4
R.i. 0 Analogue Input 0. Set the analog input to zero (zero tare)

131÷140 **Reserved Parameters - Group I**

Reserved parameters - Group I.

11.j GROUP J - *Lo.br.* - Loop Break

141 *L.b. S.* Loop Break State

- d.SRb.* Loop break disabled. (**Default**)
AutoM. Loop break enabled with automatically calculated time and band.
MANU. Loop break enabled with time (par. *Lb. t.*) And band (par. *Lb. b.*) entered by the user.

142 *L.b. t.* Loop Break Time

Sets the maximum time span allowed for a process variation to occur before the loop break error is triggered. The minimum delta variation considered is set in P_143 (*L.b. b.*)
00:01..99:59 mm:ss. **Default:** 02:00 mm:ss.

143 *L.b. b.* Loop Break Band

Sets the minimum delta process variation required to occur (within the timeframe set in P_142 *Lb. t.*) in order to avoid a loop break error
1..+10000 [digit^{1 p. 86}] (degrees.tenths for temperature sensors). **Default** 10.0°C.

144÷148 Reserved Parameters - Group J

Reserved parameters - Group J.

11.k GROUP K - *SLSP.* - Serial communication Slave (*disponibile solo su ATR144-ABC-T*)

149 *nbSL.* Modbus Slave

- d.SRb.* Disabled
ENRb. Enabled. (**Default**)

150 *SLAd.* Slave Address

Select slave mode on ATR144, for serial communication.
1..254. **Default:** 247.

151 *SL.b.r.* Slave Baud Rate

Selects baudrate for serial communication

1.2 K	1200 bit/s
2.4 K	2400 bit/s
4.8 K	4800 bit/s
9.6 K	9600 bit/s
19.2 K	19200 bit/s (Default)
28.8 K	28800 bit/s
38.4 K	38400 bit/s
57.6 K	57600 bit/s
115.2K	115200 bit/s

152 *S.S.PF.* Slave Serial Port Format

Selects the format used by the ATR144 during modbus RTU serial communication.

8-N-1	8 bit, no parity, 1 stop bit (Default)
8-E-1	8 bit, even parity, 1 stop bit
8-O-1	8 bit, odd parity, 1 stop bit
8-N-2	8 bit, no parity, 2 stop bit
8-E-2	8 bit, even parity, 2 stop bit
8-O-2	8 bit, odd parity, 2 stop bit

153 *SE.dE.* Serial Delay

Sets the serial delay
0...100 ms. **Default:** 5 ms.

154 *oFF.L.* Off Line

Selects the off-line time frame. If there is no serial communication during this period, the controller switches-off the command output

0	Offline disabled (Default)
0.1-600.0	tenths of second.

155÷159 Reserved Parameters - Group K

Reserved parameters - Group K.

11.1 GROUP L - *MRSP* – Master Serial Port *(only available on ATR144-ABC-T)*

- 160** *MRM* **Modbus Master**
MSMB. Modbus in master mode, disabled. **(Default)**
EMMB. Modbus in master mode, enabled.
ENCT Modbus in master mode, enabled for handling CT 2000.35.014.
ENCTA. Modbus in master mode, enabled for handling CT 2000.35.014 as amperometer (the current will be the process).
- 161** *MRAd* **Target Address**
Sets the slave number address used for serial communication
0..254. **Default:** 1.
- 162** *MRbr* **Master Baud Rate**
Sets the baud rate used for serial communication while the ATR144 is operating in Master mode
1.2 k 1200 bit/s
2.4 k 2400 bit/s
4.8 k 4800 bit/s
9.6 k 9600 bit/s
19.2 k 19200 bit/s **(Default)**
28.8 k 28800 bit/s
38.4 k 38400 bit/s
57.6 k 57600 bit/s
115.2k 115200 bit/s
- 163** *MRPF* **Master Serial Port Format**
Selects the format used by the ATR144 (when operating in master mode) during modbus RTU serial communication
8-N-1 8 bit, no parity, 1 stop bit **(Default)**
8-E-1 8 bit, even parity, 1 stop bit
8-O-1 8 bit, odd parity, 1 stop bit
8-N-2 8 bit, no parity, 2 stop bit

8-E-2 8 bit, even parity, 2 stop bit
8-o-2 8 bit, odd parity, 2 stop bit

164 *uAr.1* Variable 1

Selects the variable 1 used by the ATR144 in master mode.

---- Reserved

W. PRo. Write Process (**Default**)

R.W.c.SE. Read/write command setpoint

W.c.oU.P. Write command output percentage

R.W.RI.S. Read/Write Alarm 1 setpoint

W.coNS. Write constant

R. PRo. Read Process (remote process from modbus master)

165 *u.l.Ad.* Variable 1 Address

Sets the address used by the master to write/read *uAr.1* 0..65535. **Default:** 1000.

166 *LL.u.1* Lower Limit Variable 1

Lower range limit used for rescaling variable 1 -9999..+30000 [digit^{1 p. 86}] (degrees for temperature sensors). **Default:** 0.

167 *u.L.u.1* Upper Limit Variable 1

Upper range limit used for rescaling variable 1 -9999..+30000 [digit^{1 p. 86}] (degrees for temperature sensors). **Default:** 0

168 *con.1* Constant 1

Sets the constant value that will be transmitted while operating in master mode, if selected on *uAr.1* 0..65535. **Default:** 0.

- 169** `uAr.2` **Variable 2**
Selects the variable 2 used by the ATR144 in master mode.
`d.5Rb.` Disabled (**Default**)
`W. PRo.` Write Process
`R.W.c.SE.` Read/write command setpoint
`W.c.oU.P.` Write command output percentage
`R.W.A1.S.` Read/Write Alarm 1 setpoint
`W.coN.S.` Write constant
- 170** `u2Ad.` **Variable 2 Address**
Sets the address used by the master to write/read `uAr.2` 0..65535. **Default:** 1001.
- 171** `LL.u.2` **Lower Limit Variable 2**
Lower range limit used for rescaling variable 2
-9999..+30000 [digit^{1 p. 86}] (degrees for temperature sensors). **Default:** 0.
- 172** `uL.u.2` **Upper Limit Variable 2**
Upper range limit used for rescaling variable 2
-9999..+30000 [digit^{1 p. 86}] (degrees for temperature sensors). **Default:** 0
- 173** `con.2` **Constant 2**
Sets the constant value that will be transmitted while operating in master mode, if selected on `uAr.2`.
0..65535. **Default:** 0.
- 174** `tr.dE.` **Transmission Delay**
Defines the minimum delay introduced by the modbus master protocol between the full data reception by the slave and a new query.
0..200 ms. **Default:** 2 ms.

175 *rE.tO.* Reception Timeout

Defines the maximum wait time (after sending a query to the slave) before reception is canceled due to a timeout.

When this happens, the lost packet counter will be increased.

10..1000 ms. **Default:** 100 ms.

176 *nu.Er.* Number of Errors

Defines the maximum number of allowed subsequent faults (reception timeouts, CRC errors) before the slave status is notified as offline.

Any successful communication will reset the fault counter for off-line management to zero.

Setting this parameter to 0 will prevent the error notification

0..100. **Default:** 10.

177÷185 Reserved Parameters - Group L

Reserved parameters - Group L.

11.m GROUP M - *t i n r* - Timer

186 *t i n r.1* Timer 1

Enables timer 1

d i s A b. Disabled (**Default**)

E n A b. Enabled

E n. S t A. Enabled and active at start

187 *t. b. t. 1* Time Base Timer 1

Selects the time base used by timer 1

mm.ss minutes.seconds (**Default**)

HH.mm hours.minutes

- 188** **A.ET.1** **Action Timer 1**
 Selects the type of action performed by timer 1 when connected to an alarm
START Start. Active during timer counting (**Default**)
END End. Active at timer expiry
WARN. Warning. Active 5" before the timer expiry
- 189** **ET.2** **Timer 2**
 Enables timer 2
DISAb. Disabled (**Default**)
ENAb. Enabled
EN.STR. Enabled and active at start
- 190** **E.b.t.2** **Time Base Timer 2**
 Selects the time base used by timer 2
MM.SS minutes.seconds (**Default**)
HH.MM hours.minutes
- 191** **A.ET.2** **Action Timer 2**
 Selects the type of action performed by timer 2 when connected to an alarm
START Start. Active during timer counting (**Default**)
END End. Active at timer expiry.
WARN. Warning. Active 5" before the timer expiry.
- 192** **ET.5.** **Timers Sequence**
 Select the correlation between the two timers.
SINGL. Singles. Timers work independently (**Default**)
SEQUE. Sequential. When timer 1 expires, timer 2 starts.
Loop Loop. When a timer expires, another one starts.
- 193÷197** **Reserved Parameters - Group M**
 Reserved parameters - Group M

12 Alarm Intervention Modes

12.a Absolute or threshold alarm active over (par. 62 $RL.IF. = Ab.uPA$)

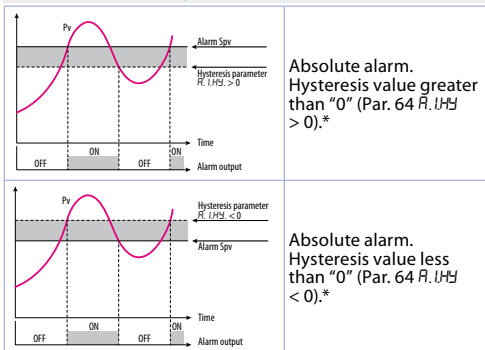

12.b Absolute or threshold alarm referred to command setpoint active over (par. 62 $RL.IF. = Ab.c.uPA$)

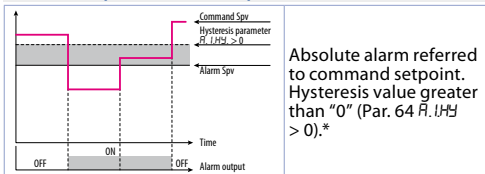

12.c Band alarm (par. 62 $R.L.I.F. = bR\Delta d$)

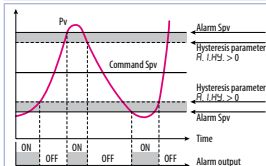

Band alarm hysteresis value greater than "0" (Par. 64 $R.I.H.Y. > 0$).*

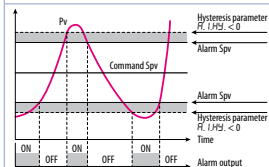

Band alarm hysteresis value less than "0" (Par. 64 $R.I.H.Y. < 0$).*

12.d Asymmetric band alarm (par. 62 $R.L.I.F. = R.bR\Delta d$)

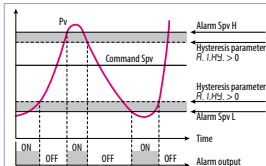

Asymmetric band alarm hysteresis value greater than "0" (Par. 64 $R.I.H.Y. > 0$).*

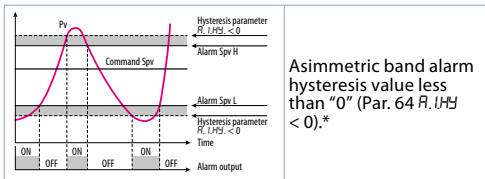

Asymmetric band alarm hysteresis value less than "0" (Par. 64 $R.I.H.Y. < 0$).*

* The example refers to alarm 1; the function can also be enabled for alarm 2 on model that include it.

12.e Upper deviation alarm (par. 62 $R.L.I.F. = uP.dE_u$)

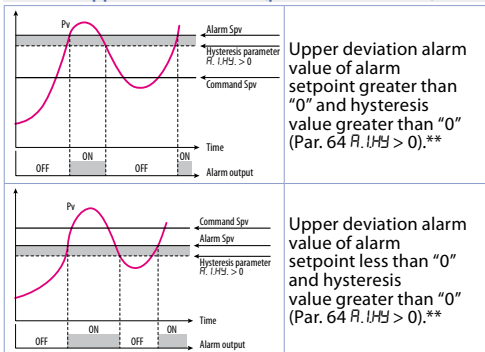

Upper deviation alarm value of alarm setpoint greater than "0" and hysteresis value greater than "0" (Par. 64 $R.I.H.Y. > 0$).**

Upper deviation alarm value of alarm setpoint less than "0" and hysteresis value greater than "0" (Par. 64 $R.I.H.Y. > 0$).**

12.f Lower deviation alarm (par. 62 $R.L.I.F. = Lo.dE.u.$)

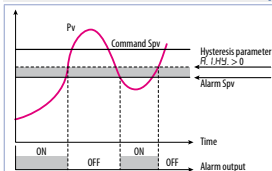

Lower deviation alarm value of alarm setpoint greater than "0" and hysteresis value greater than "0" (Par.64 $R.L.I.F. > 0$).**

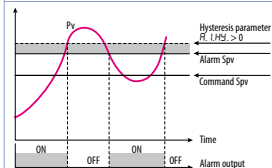

Lower deviation alarm value of alarm setpoint less than "0" and hysteresis value greater than "0" (Par. 64 $R.L.I.F. > 0$).**

** a) The example refers to alarm 1; the function can also be enabled for alarm 2 on model that include it. b) With hysteresis less than "0" ($R.L.I.F. < 0$) the segmented line moves above the alarm setpoint.

12.1 Alarms label

By setting a value from 1 to 16 on the parameters 72 *ALb.* and 88 *ALb.*, the display 2 will show one of the following messages in case of alarm:

Selection **Message displayed in the alarm event**

1	ALARM 1	9	HIGH LIMIt
2	ALARM 2	10	LOW LIMIt
3	oPEN dooR	11	EXtERnAL ALARM
4	cLOSEd dooR	12	TEMPERAtURE ALARM
5	LIGHt oN	13	PRESSURE ALARM
6	LIGHt oFF	14	FAN coMMANd
7	WARNING	15	cooLing
8	WARNING	16	oPERRING

In case you set 0, no message will appear. In case the user sets 17, 23 characters will be available to personalize the message using MyPixsys app or modbus.

13 Table of anomaly signals

If installation malfunctions, the controller switches off the regulation output and reports the anomaly noticed. For example, controller will report failure of a connected thermocouple visualizing *E-05* (flashing) flashing on display. For other signals see table below.

	Cause	What to do
<i>E-02</i> SYStEM Error	Cold junction temperature sensor failure or environment temperature out of range	Call assistance
<i>E-04</i> EEPROM Error	Incorrect configuration data. Possible loss of instrument calibration	Verify that configuration parameters are correct.

	Cause	What to do
E-05 Probe 1 Error	Sensor connected to AI1 broken or temperature out of range	Control connection with probes and their integrity.
E-07 SERIAL Error	Communication error in modbus master	Check the configuration parameters and the RS485 serial connection
E-08 SYSTEM Error	Missing calibration	Call assistance
E-80 rFid Error	RFID tag malfunction	Call assistance

Notes / Updates

- 1 *Display of decimal point depends on setting of parameter SE_n and parameter d.P.*
- 2 *On activation, the output is inhibited if the controller is in alarm mode. Activates only if alarm condition reappears, after that it was restored.*
- 3 *Changing the control setpoint, the alarm will be disabled. It will stay disabled as long as the parameters that created it are active. It only works with deviation alarms, band alarms and absolute alarms (referring to the control setpoint).*

Read carefully the safety guidelines and programming instructions contained in this manual before using/connecting the device.

Prima di utilizzare il dispositivo leggere con attenzione le informazioni di sicurezza e settaggio contenute in questo manuale.

Avant d'utiliser le dispositif lire avec attention les renseignements de sûreté et installation contenus dans ce manuel.



RoHS 
Compliant



UL **US**
LISTED
Proc. Cont. Eq.
E469441

PIXSYS s.r.l.

www.pixsys.net

sales@pixsys.net - support@pixsys.net

online assistance: <http://forum.pixsys.net>

via Po, 16 I-30030

Mellaredo di Pianiga, VENEZIA (IT)

Tel +39 041 5190518



2300.10.293-RevE
Firmware version 1.01
021219